

COVANA

OASIS INSTALLATION MANUAL

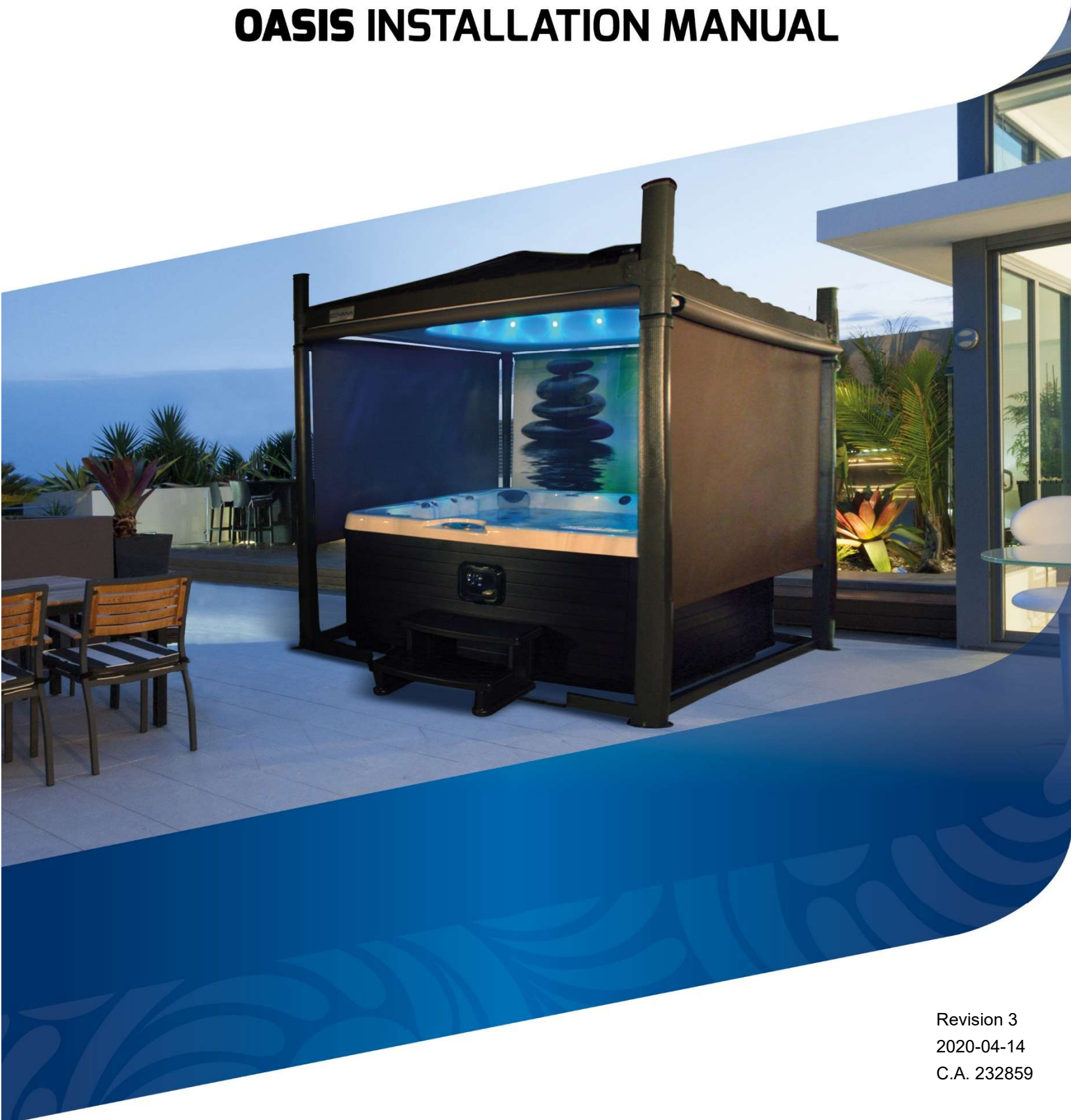

Revision 3
2020-04-14
C.A. 232859

TABLE OF CONTENTS

TABLE OF CONTENTS	2
SAFETY	4
Safety information.....	4
Avoiding the risk of electrocution.....	5
LABELING	7
GLOSSARY	9
HARDWARE IDENTIFICATION TABLE	13
INSTALLATION PREPARATION	15
Location considerations.....	15
Foundation preparation.....	16
INSTALLATION	17
Tools required.....	17
HANDLING	17
Uncrating.....	19
Assembly preparation.....	24
Lifting mechanism assembly.....	25
AC light kit installation.....	29
Lifting mechanism assembly (continued).....	35
Testing the Oasis cover.....	37
Non-permanent mounting plate installation.....	38
Seal application.....	39
ELECTRICAL HOOK-UP	41
Avoiding the risk of electrocution.....	41
Grounding and power supply connection.....	42
TECHNICAL SPECIFICATIONS	43
Side elevation.....	43
Frame dimensions and foot print.....	44
Electrical specifications.....	46
Operating limitations.....	46

General specifications	46
LIMIT SWITCH ADJUSTMENT	47
TROUBLESHOOTING	48
APPENDIX	50
.....	52
.....	54
.....	56
INSTALLATION CHECKLIST (Customer copy).....	59
INSTALLATION CHECKLIST (Installer copy).....	61

SAFETY

IMPORTANT SAFETY INSTRUCTIONS

SAVE THESE SAFETY INSTRUCTIONS AND REVIEW THEM REGULARLY.

READ AND FOLLOW ALL INSTRUCTIONS

Safety information

The COVANA cover was designed, tested and certified to be installed over a residential hot tub (spa) and under important installation instructions issued by COVANA. Any other type of usage will void the warranty and product certification.

The extra load maximum weight provided in the specification section of this manual is a provision for environmental outcomes, such as some snow or damp leaves that could accumulate on the cover, that are evenly distributed on the surface of the cover.

The power safety cover meets ASTM F1346-91 requirements.

⚠ DANGER

- ♦ To reduce the risk of injury, do not allow children to use this product unless they are supervised at all times.
- ♦ Failure to follow all instructions may result in injury or even death.
- ♦ Do not allow people to climb on the cover at any time.
- ♦ Do not allow children to have access to the COVANA cover without supervision.
- ♦ Never operate the COVANA cover until all people and objects are out of the spa.
- ♦ Lower the COVANA cover in extreme wind conditions such as gusts of 30 mph (50 km/h) in the raised position and upwards of 45 mph (70km/h) when completely lowered on the hot tub.

⚠ WARNING

- ♦ Be sure to keep the key switch and the key out of the reach of children.

- ♦ Do not put any type of fabric or plastic sheet, such as a tarpaulin, on the COVANA cover. This could overheat the cover and result in deformation or melting of the cover.
- ♦ Inspect the cover periodically. It should raise smoothly and evenly. Contact your COVANA dealer if any unusual sound is heard during use.
- ♦ Never use any type of pressure washer or buffer to clean any surface of the COVANA cover. This could result in premature wear or damage.

DO

- ♦ Remove the control key after operating the COVANA cover. Store the key in a secure location when not in use. Users must bring the control key in the hot tub with them to prevent unauthorized operation of the cover.
- ♦ Never leave the key in the key switch.
- ♦ Check the cover frequently for signs of deterioration.
- ♦ Have any repairs, adjustments or mechanical work performed by your authorized COVANA dealer as soon as possible should you notice a malfunction.
- ♦ Close cover when not in use or if the hot tub is not being monitored.
- ♦ A COVANA cover should only be operated by an adult.
- ♦ This appliance can be used by children aged 8 years and above and persons with reduced physical, sensory or mental capabilities or lack of experience and knowledge **ONLY** if they are supervised or have received instructions regarding safe use of the cover. Children must not play with the appliance. Cleaning and user maintenance must not be performed by children without supervision.

DO NOT

- ♦ Operate the unit before all mechanical and electrical connections are completed.
- ♦ Step on or stack anything on the COVANA operator cover.
- ♦ Operate the COVANA cover while somebody is in the hot tub.
- ♦ Climb, walk or stand on the COVANA cover at any time.
- ♦ Leave the COVANA cover open for more than 12 hours. This could cause the cover to warp over time.
- ♦ Converge or directly reflect sunlight on the cover. This could cause permanent damage.
- ♦ Wash the cover with harsh chemicals or cleaners.

- ♦ Use a pressure washer to clean any component of the COVANA cover. This could result in premature wear or damage.
- ♦ Use an extension cord to connect the COVANA cover to its power source. The cord may not be properly grounded, and the connection is a shock hazard. An extension cord may cause a voltage drop, which would cause the motor to overheat.

⚠ CAUTION

- ♦ Be sure to follow all instructions in this manual and use only COVANA-approved accessories and tools.
- ♦ Do not roll the COVANA cover onto its side or slide it on its side. This will damage the siding.
- ♦ After removing any part, always place it in a safe place on a clean and level surface to ensure proper functionality.
- ♦ All four posts of the COVANA cover must be properly anchored to the foundation using the anchoring holes located at the foot of each post. The optional non-permanent mounting plates can be used when anchoring is not possible, but under strict condition. See *Non-permanent mounting plates installation* section on Installation Manual for further details.
- ♦ This product mainly contains steel, plastic, copper (Cu) and die-cast aluminum (Al). The gearbox contains oil and other materials. Please recycle them properly.
- ♦ Both the up and down limit switches are pre-adjusted at the factory. The down-limit switch should never be re-adjusted. The up-limit switch should be re-adjusted only to reduce the maximum height of the cover to avoid possible contact with its surroundings. Please refer to the *Limit Switch Adjustment* section in this manual before making any adjustments. An improper adjustment can result in damage to the drive system and/or cover.

Avoiding the risk of electrocution

⚠ ELECTRICAL DANGER

- ♦ Failure to comply with these instructions may result in death by electrocution or serious injury. Disconnect or turn off and secure all power supplies before starting any intervention on the COVANA cover.

- ♦ A disconnect mean needs to be incorporated into the fixed wiring at the time of installation. This mean must be accessible to the user or service technician to turn the power off for future maintenance or repair.
- ♦ Always have a licensed electrical contractor perform any electrical maintenance or repairs on the COVANA cover. The wiring must comply with all applicable local electrical codes and regulations.
- ♦ The COVANA operator must be connected to a circuit that is protected by a dedicated ground fault circuit interrupter (GFCI) that complies with all applicable local electrical codes and regulations.
- ♦ Install the COVANA cover in such a way that drainage directs water away from the electrical and base mechanical components.
- ♦ Do not connect any auxiliary components to the electrical system of the COVANA cover unless they have been approved by COVANA.
- ♦ Replace electrical components with original components provided or approved by COVANA. Ask your dealer for replacement parts.
- ♦ To reduce the risk of electrical shock, replace all damaged electrical cables immediately. Failure to do so may result in death or serious personal injury due to electrocution.
- ♦ Do not bury any electrical cables. A buried cable may result in death, or serious personal injury due to electrocution if direct burial-type cable is not used, or if improper digging occurs.

⚠ ELECTRICAL WARNING

- ♦ To reduce the risk of electric shock, the green-colored terminal or the terminal marked “g,” “gr,” “ground,” “grounding” or with a \equiv symbol that is located inside the supply terminal box or compartment must be connected to the grounding means provided in the electric supply service panel with a continuous copper wire equivalent in size to the circuit conductors supplying the equipment.
- ♦ Two lugs marked “bonding lugs” are provided on the external surface or on the inside of the supply terminal box or compartment. To reduce the risk of electric shock, connect the local common bonding grid in the area of the COVANA cover. Use terminals with an insulated or bare copper conductor not smaller than No. 6 AWG (4.11 mm).

- ♦ All field-installed metal components, such as rails, ladders, drains or other similar hardware, within 10 ft. (3 m) of the hot tub must be bonded to the equipment grounding bus with copper conductors no smaller than No. 6 AWG (4.11 mm). (NEC art. 680.)

⚠ WARNING REGARDING DRUG OR ALCOHOL USE

- ♦ The use of drugs or alcohol while operating the COVANA cover is strictly prohibited. The impairment of judgement, vision or hearing might affect the safety of other people or result in death.

⚠ WARNING REGARDING MODIFICATIONS TO THE COVANA COVER

- ♦ Any modifications to the COVANA cover, such as mechanical, electrical or aesthetic ones, may cause the cover to operate in an unwanted or dangerous way. Furthermore, these modifications might void the warranty and certification.
- ♦ The COVANA cover was designed, tested and certified for the sole purpose of covering and securing a spa. Any installation that differs in whole or in part from this purpose will void the warranty and certifications.

SAVE THESE INSTRUCTIONS

LABELING

⚠ WARNING

Removing any labels from the COVANA cover will void product certification. All labels should always remain visible. It is the owner's responsibility to ensure that these labels are always visible and should never be removed.



Risk of electrocution warning, located on the operator unit.

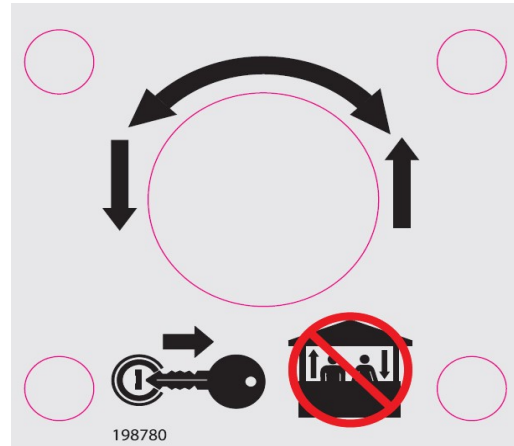

Key operating diagram, located on the key switch

⚠ WARNING

AVOID DROWNING RISK. ENTRAPMENT POSSIBLE.
FAILURE TO FOLLOW ALL INSTRUCTIONS MAY RESULT IN INJURY OR DROWNING.
INSPECT COVER PERIODICALLY.
POWER SAFETY COVER MEETS ASTM F1346-91 (2010) REQUIREMENTS.
FOR FURTHER INFORMATION CONTACT : www.covana.com

Drowning risk warning, located on all four sides of the COVANA cover

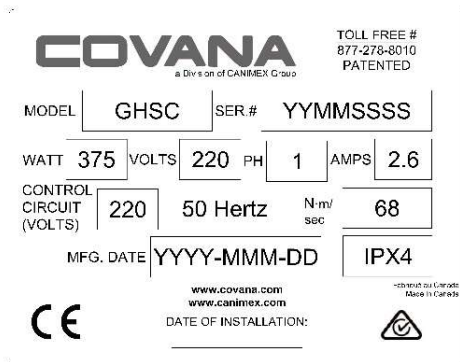

Specification label, located on the operator unit. (European model)

NOTE: This label provides the serial number.

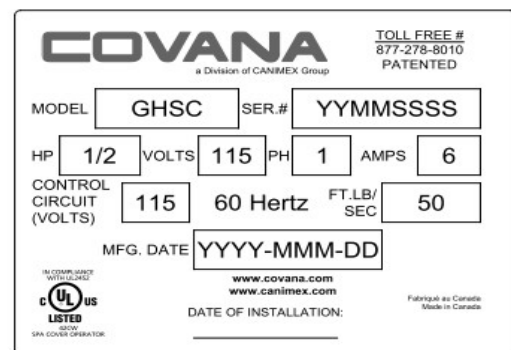

Specification label, located on the operator unit. (North American model)

NOTE: This label provides the serial number.



Key switch warning, located on the key switch.



200350

Do not step symbol, located on top of the operator unit.

198782

Visit www.covana.com
for recommended maintenance
procedures and videos
This label not to be removed except by the consumer

Visitez www.covana.com
pour des conseils et des vidéos
sur les procédures d'entretien
Seul l'utilisateur peut retirer cet autocollant

MADE IN CANADA
FABRIQUÉ AU CANADA

Maintenance information, located on the outershell.

200356

LIRE LE MANUEL
D'INSTRUCTION

!
ATTENTION

READ THE
INSTRUCTION MANUAL

!
CAUTION

CAUTION

CONNECT ONLY TO A
CIRCUIT PROTECTED BY A CLASS
A GROUND FAULT CIRCUIT
INTERRUPTER







!
ATTENTION







CONNECTER UNIQUEMENT
À UN CIRCUIT PROTÉGÉ PAR UN
DISJONCTEUR DIFFÉRENTIEL
DE CLASSE A

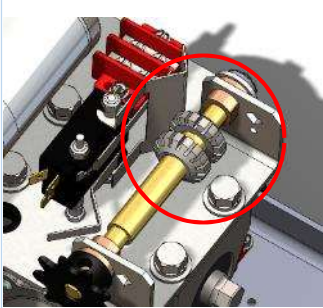

Electrical information, located on the key switch cable.

GLOSSARY











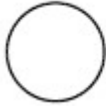
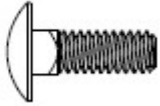

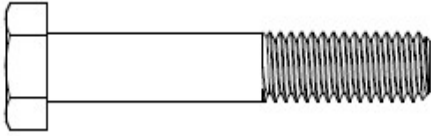

Part	Figure	Function
All-weather seal	 <p data-bbox="516 510 597 535">Figure 1</p>	The all-weather seal will help protect sleeves from damage due to weather.
Contour seal	 <p data-bbox="503 730 584 756">Figure 2</p>	The contour seal ensures uniform contact between the inner shell and the hot tub.
Contour seal installation clip	 <p data-bbox="503 966 584 991">Figure 3</p>	Contour seal installation clips are used during the installation process to ensure the seal is installed properly.
Contour seal connector	 <p data-bbox="495 1197 576 1222">Figure 4</p>	The seal connector is used to link both ends of the seal.
Corner bracket	 <p data-bbox="487 1417 568 1442">Figure 5</p>	The corner bracket links the cover to the sleeves.
CTS-70 (Continuous tension system) (optional)	 <p data-bbox="503 1722 584 1747">Figure 6</p>	The CTS-70 is in the roof of the Oasis cover. It keeps the wire perfectly taut throughout the cover's up and down cycles.

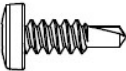

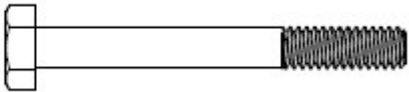
<p>Drive shaft</p>	 <p>Figure 7</p>	<p>The drive shaft transmits the power between the motor-side and non-motor-side jack assemblies.</p>
<p>Foot bracket</p>	 <p>Figure 8</p>	<p>The foot brackets provide a solid footing for the COVANA cover and are assembled with the jacks.</p>
<p>Front frame cut-out</p>	 <p>Figure 9</p>	<p>The front frame cut-out gets installed under the front step of your hot tub. It links the two non-motor-side posts.</p>
<p>Inner shell</p>	 <p>Figure 10</p>	<p>The inner shell is the insulating part of the cover.</p>
<p>Installation foam</p>	 <p>Figure 11</p>	<p>The installation foam is used during the installation process to protect the hot tub from direct contact with the cover.</p>
<p>Jack lock bolt</p>	 <p>Figure 12</p>	<p>The jack lock bolts prevent the non-motor jacks from extending. Do not remove this bolt until the drive shaft is connecting the motor-side jack to the non-motor-side jack. Follow the installation steps carefully.</p>
<p>Key switch</p>	 <p>Figure 13</p>	<p>The key switch is used to operate the COVANA cover.</p>

<p>Limit switch</p>	 <p>Figure 14</p>	<p>The limit switches are located in the operator. Refer to the <i>Limit Switch Adjustment</i> section for further details.</p>
<p>Motor frame</p>	 <p>Figure 15</p>	<p>The motor frame is composed of the two motor-side jacks and the operator.</p>
<p>Non-motor-side and moto-side jack</p>	 <p>Figure 16</p>	<p>The non-motor jacks are a main part of the COVANA cover. They and the motor-side jacks enable the cover to move.</p>
<p>Operator</p>	 <p>Figure 17</p>	<p>The operator powers and controls the lifting mechanism of the COVANA cover.</p>
<p>Outer shell</p>	 <p>Figure 18</p>	<p>The outer shell is the outside part of the cover.</p>
<p>Sleeve</p>	 <p>Figure 19</p>	<p>The sleeve is an aluminum case for the lifting mechanism.</p>

<p>U-frame</p>	 <p>Figure 20</p>	<p>The U-frames protect the mechanical parts resting on the foundation and connect all four posts.</p>
<p>Wire guard (optional)</p>	 <p>Figure 21</p>	<p>The wire guard is an assembly that will house a wire that comes from the cover to light up the LED light kit on your Oasis cover. It protects the wire from becoming overly taut and will release extra wire if this happens.</p>

HARDWARE IDENTIFICATION TABLE

Quantity	Visual representation		Description
4			1/4"-20 x 3/4" carriage bolt used to assemble the front frame cut-out.
17			5/16"-18 x 2" hexagonal bolt used to assemble the lower frame.
19			M6 x 20 mm screw used to hold the inner and outer shell together.
17			#8 x 1/2" self-drilling Robertson screw used to fasten the inner sleeve to the COVANA cover.
4			1/4"-20 x 2 1/4" hexagonal bolt used to assemble the feet of the posts.
8			1/4"-20 Nylon-insert locknut. Used to assemble the feet of the posts and the front cut-out.
17			5/16"-18 nylon-insert locknut used to connect the U-frames.
1			#2 x 2" Robertson bit.

33		5/16" nylon washer used to connect the U-frames
17		5/16" painted washer.
2		1/4" nylon washers used to fasten the bottom of the sleeves with M6 x 20 mm screw.
2		M6 clip-on barrel nut used to secure the sleeve at the bottom of each post.

INSTALLATION PREPARATION

To ensure safe use of the COVANA cover, it must be installed on a properly prepared surface. It is important to adequately prepare the foundation and carefully read the following recommendations.

Location considerations

- ◆ Ensure the future COVANA cover location is not subjected to water downpour or debris falling from another roof or covering.
- ◆ Ensure that the base of the COVANA cover is not in a flood zone. Any damage caused by flooding or water accumulation will not be covered under the warranty.
- ◆ Ensure there are no obstacles, such as branches or electrical power lines, in the operating range of the COVANA cover.
- ◆ Refer to the *Technical specifications* section for cover dimensions.
- ◆ Ensure there is safe access to the hot tub, free of obstacles or debris.
- ◆ All the base components of the COVANA cover must be supported by the foundation.
- ◆ Do not converge or directly reflect sunlight on the cover. This could cause permanent damage (i.e.: reflection by a window).

- ◆ Ensure the COVANA cover is installed on a clean surface free of any vegetation, such as grass, branches or roots, or mineral contaminants, such as rocks, dust or sand.
- ◆ The key switch must be permanently mounted and located 5 ft (1.5 m) away from the hot tub and 5 ft (1.5 m) above the deck or ground level. This ensures the user has a clear view of the COVANA cover when operating it. Furthermore, the key switch terminal should be located in a place where no water downpour or debris could fall on it. (Figure 22)

⚠ WARNING

- ◆ Failure to permanently install the key switch as indicated could cause serious injury or even death and void the warranty and certification. Only proper installation of the key switch combined with the suggested procedures and caution will reduce such risks.
- ◆ Do not place the cover in an area prone to snow accumulation and water runoff.

⚠ DANGER

- ◆ Failure to properly install the key switch according to these instructions could result in injury or even death.

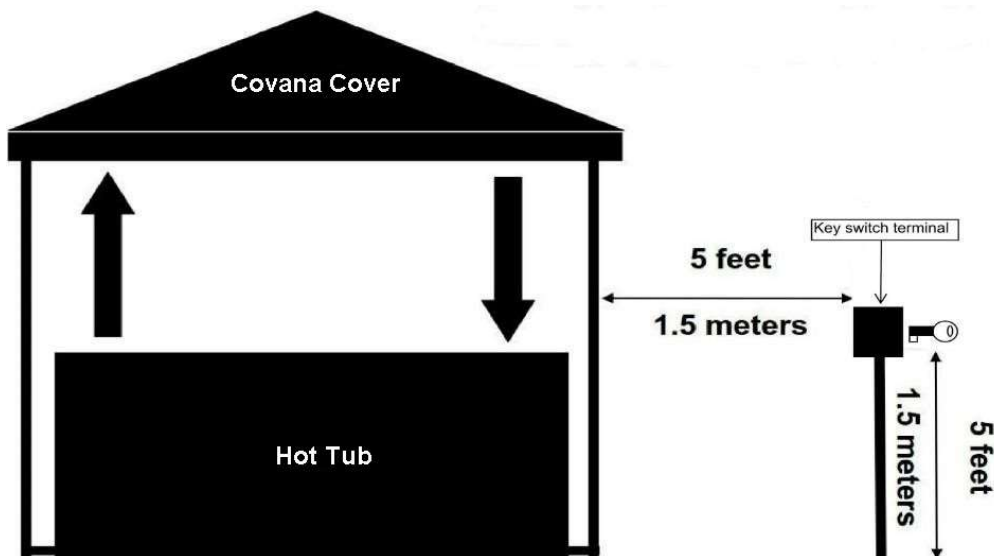

Figure 22

Foundation preparation

- ♦ The Oasis cover requires a clean, flat and level surface, such as an engineered wood deck or a concrete slab.
- ♦ Each of the four jacks of the COVANA cover must be properly anchored to the foundation using at least one of the pre-drilled holes located at the foot of each post. Use a 1/4 in. (6 mm) concrete anchor for concrete pads or a 1/4 in. (6 mm) lag bolt for wood foundations and insert minimum 1 1/4 in. (30 mm) deep. If you cannot meet these requirements, install a set of non-permanent mounting plates.

⚠ WARNING

- ♦ The non-permanent mounting plates can only be used in areas with low winds (less than 30 mph (50 km/h) when open and less than 45 mph (70 km/h) when closed).
- ♦ The non-permanent mounting plates must also be properly installed.
- ♦ Just like the hot tub, the COVANA cover requires a solid foundation. The foundation for the COVANA cover must be able to support at least 600 lb. (272 kg).
- ♦ The foundation must be leveled with a maximum tolerance of 1 in (2.54 cm) over a 144 in (3.65 m) diagonal section. (Figure 23). Refer to *Frame and foot print section* for information on the minimum base size.
- ♦ The annual variation in levelness for the same diagonal section cannot exceed 1/4 in (6 mm).

⚠ CAUTION

- ♦ Damage caused by inadequate foundation construction is not covered by the COVANA warranty. It is the responsibility of the owner to provide a proper foundation.
- ♦ Failure to follow these guidelines might cause permanent damage or improper functioning of the COVANA cover. Such damage might not be covered by the warranty.

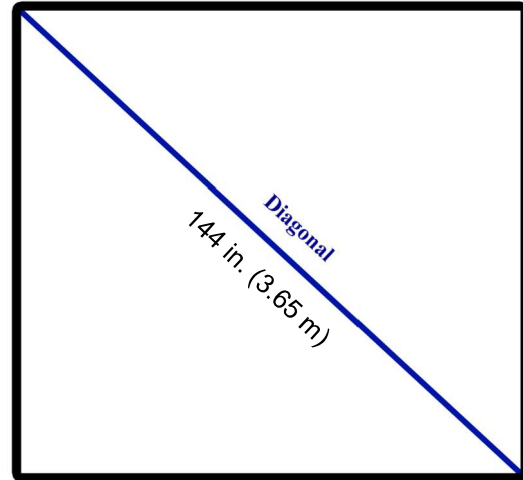

Figure 23

INSTALLATION

Tools required

- ♦ Scissors or a utility knife
- ♦ Robertson screwdriver
- ♦ Hammer
- ♦ Slotted screwdriver
- ♦ Phillips screwdriver
- ♦ 3/8" (10 mm) socket wrench and spanner
- ♦ 7/16" (11 mm) socket wrench and spanner
- ♦ 1/2" (13 mm) socket wrench and spanner
- ♦ 7/32" (5.5 mm) Allen key
- ♦ 25' (7.62 m) measuring tape
- ♦ Rubber mallet
- ♦ Socket kit
- ♦ 48" (122 cm) level

⚠ CAUTION

- ♦ The COVANA cover should be installed by a certified COVANA installer. Having the COVANA cover installed by someone who is not certified will void the warranty. Ask your local COVANA dealer for information on certified installers.

HANDLING

Minimum requirements:

The forklift used must have a minimum capacity of 5000 lb.(2268kg) at 24" (609.6mm) from the fork arm and 96" (2.44m) length fork (Figure 25)

OR

64" (1.6m) with 96" (2.44m) extension fork (Figure 24).

Also, overall total grip of 16" (431.8mm) in both setups. (Figure 26)

Upon delivery:

During the delivery process with the carrier, if you notice any sign of damage to the crate that could compromise the stability, the transportation or unloading of the crate, there is a high risk that the merchandise is also damaged. (Figure 27)

Do not attempt anything that could compromise the safety of your crew.

Refer to the COVANA **Damaged claim** form attached to the crate, take pictures and simply refuse the delivery from the carrier. (Figure 28)

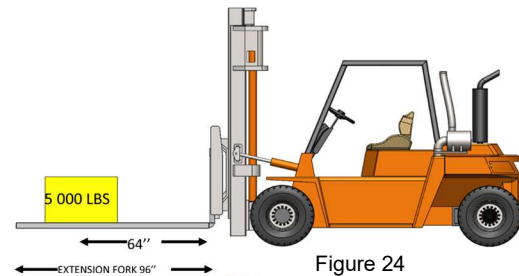

Figure 24

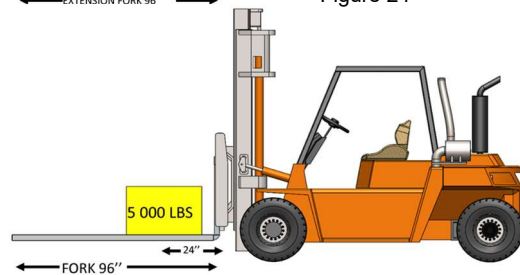

Figure 25

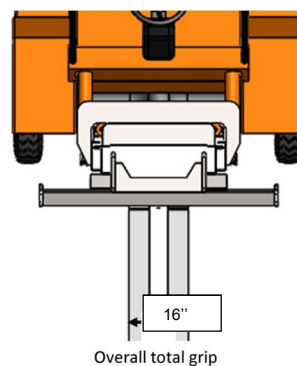

Figure 26



Figure 27



Figure 28

Secure the crate:

Before unloading the merchandise, for security and safety, the crate must be secured to the forklift with Ratchet Tie Down Straps or similar tools. (Figure 29 and 30)

Always make a visual inspection of the condition of the crate before attempting any action with the forklift.

If the crate is unstable prior to any attempt, this is already a safety risk.

Secure perimeter:

Before or while handling the crate with the forklift or any other lifting tool, the forks should be fully under the crate before any elevation and should be moved by one of the two short sides indicated on the crate.

No one should be in front, beside or around within 12 feet (3.6m) of the crate being handled. The crate should not be kept higher than 6''(152mm) from the ground at all time to avoid injury to all personnel. (Figure 31)

Make sure the forklift is stopped and the crate down and stable on the floor before approaching the crate for further handling or uncrating. If the crate seems unbalance, unstable, tilting or wobbly, do not attempt any action in any circumstances to stabilize by hand.

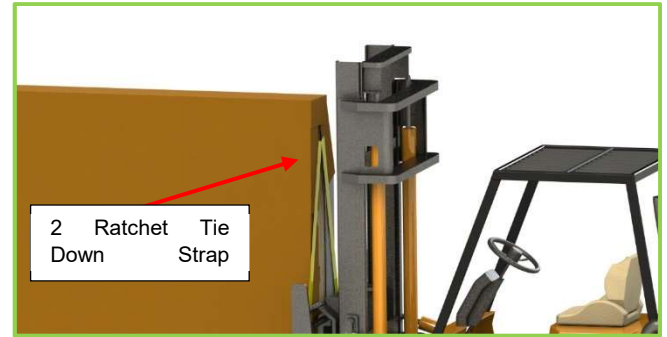

Figure 29

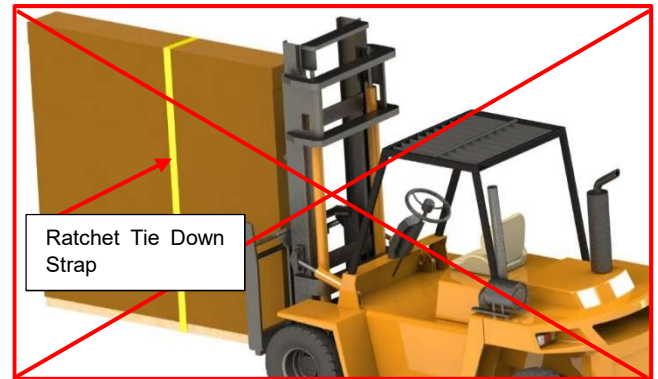

Figure 30

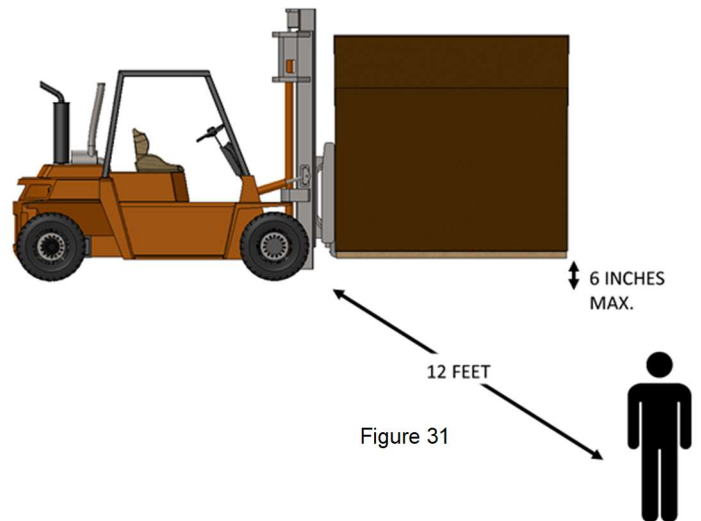

Figure 31

Uncrating

- 1) Before uncrating the unit, ensure there is no visible damage to the crate. In case of any suspicious damage, take pictures first and please call COVANA customer service immediately. Always stand the crate in the vertical position. Ensure that the uncrating can be done safely given the wind conditions. (Figure 32)
- 2) Remove the cardboard on the front side. (Figure 32)
- 3) Hammer off the wood furring strip by hitting on the inside of the side panels. (Figure 33)

⚠ CAUTION

- ◆ Be careful not to damage the cover components and other parts in the crate. (Figure 33)
- ◆ Flatten any protruding nails.

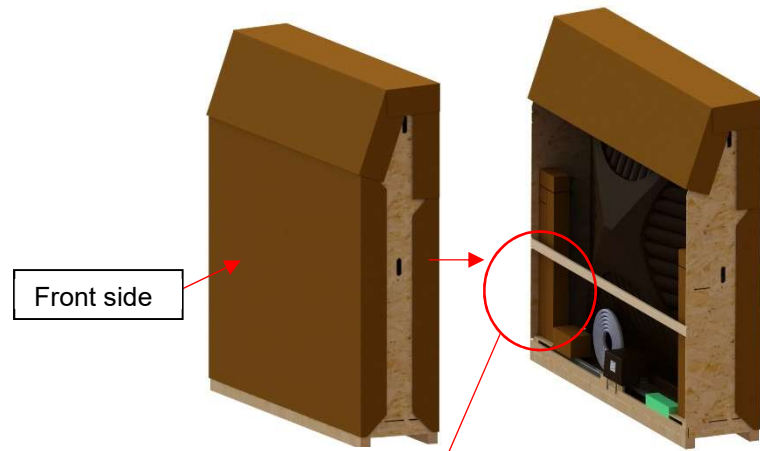

Figure 32

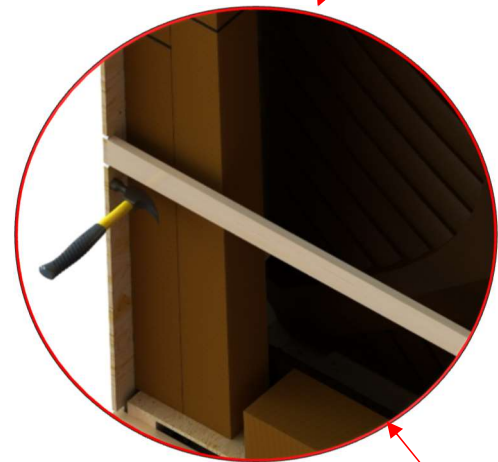

Figure 33

Furring

- 4) Remove the parts box, the foam pieces and the seal from the crate. Temporarily put these items in a safe place. (Figure 34)
- 5) Use scissors or a utility knife to cut the four cable ties holding the sleeve boxes (2 boxes per side) and discard the cable ties. (Figure 35)

⚠ CAUTION

- ♦ When using the utility knife or scissors, be careful not to puncture the cardboard box.
- 6) Remove the four sleeve boxes from the crate and place them in a safe place. (Figure 35)
 - 7) Use a slotted screwdriver to remove the two slotted #10-24 x 3/8" screws holding the operator in place. (Figure 36)
 - 8) Bend the metal strapping all the way back and reinstall the screws on the operator. (Figure 36)
 - 9) Use the 3/8" (10 mm) socket wrench to unscrew the hexagonal 1/4"-14 x 2" lag bolts on the bottom of both jacks. There are two lag bolts per side. (Figure 37)

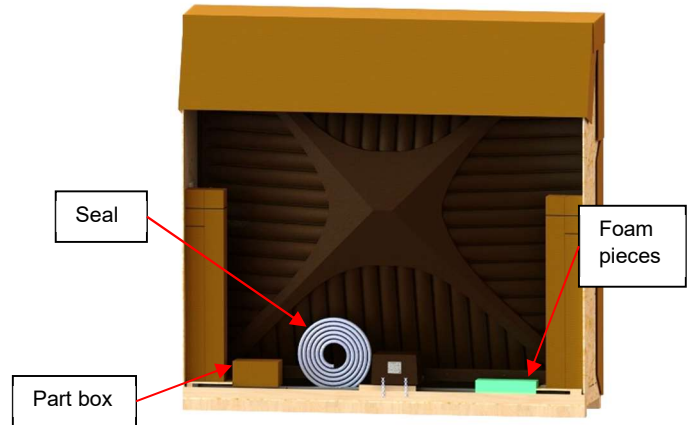

Figure 34



Figure 35

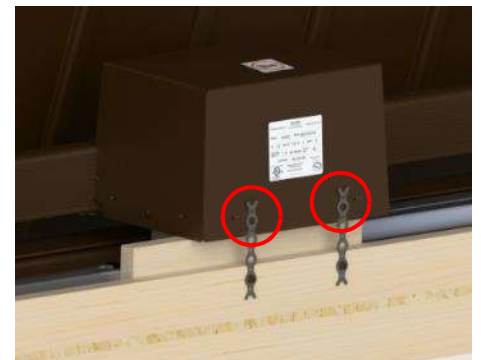

Figure 36



Figure 37

- 10) For each jack, use the 7/32" (5.5 mm) Allen key to loosen—but not fully remove—the 3/8"-24 x 1" bolt holding the jack to the bracket. There is one bolt per side. **Do not discard this bolt and bushing; they are required to assemble the COVANA cover.** (Figure 38)

NOTE: DO NOT remove the alignment bracket (red part) on jack.

- 11) Remove the white foam paper on the cover's top. (Figure 39)

- 12) With the help of another person, remove the motor frame assembly from the crate. Place one hand under the horizontal portion of the motor frame and the other one on the vertical jack. (see Figure 39 for hand positioning). Handle and carry the assembly with care, so that the jacks follow the natural bending of the U-frame. Place the motor frame on a level surface to ensure the assembly does not fall. (Figure 39)

⚠ CAUTION

- ◆ Do not twist the assembly, since this may cause mechanical failure to the operator and chain assembly.
- ◆ Jacks may be greasy; wash your hands after handling them or use gloves.

- 13) Pry off the footing piece of wood using your hands or a hammer if needed. There is one piece per side. (Figure 40)

⚠ CAUTION

- ◆ Do not damage the jack or frame components resting at the bottom of the crate.
- ◆ Flatten any protruding nails.



Figure 38

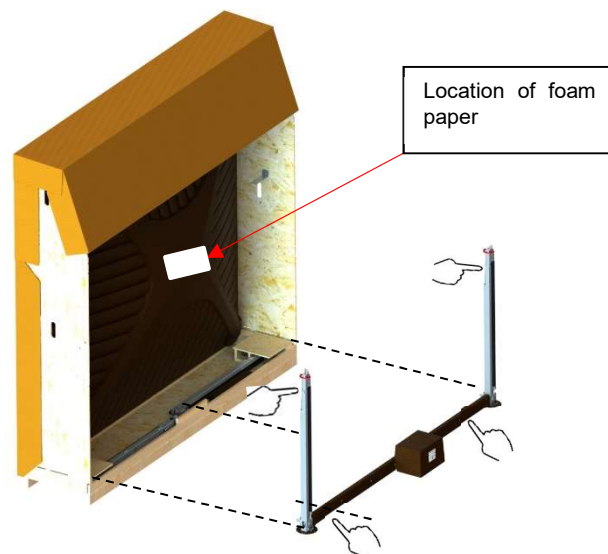

Figure 39

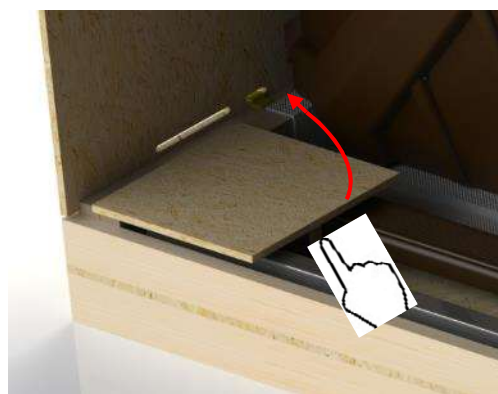

Figure 40

- 14) Remove the two long U-frame pieces, the two short U-frame pieces and both jacks located at the bottom of the crate. Lay these parts down in a safe place. (Figure 41)

⚠ CAUTION

- ♦ The small U-frames are nailed in; remove them by hand to prevent any aesthetic damage.

- 15) With the help of another person, gently lay the crate horizontally on its back by using the pivot point. (Figure 42) There should be one person on each side of the crate.

⚠ CAUTION

- ♦ Dropping the crate could damage the cover.

- 16) Remove the cardboard top and sides by simply unfolding them on the ground. (Figure 42)

- 17) If your COVANA cover was delivered with roller shades, remove the cardboard cylinders from the holes in the side panels and place them in a safe place.

- 18) Gently hammer off the last wood furring strips on the front of the crate. **Consider hammering the side panel in an outward direction to prevent damaging the COVANA cover.** (Figure 43)

⚠ CAUTION

- ♦ Be careful not to damage the cover during this process. (Figure 43)

- 19) Step 1: Use a Phillips screwdriver to remove the two M6 x 20 mm screws. Step 2: Use a 3/8" (10 mm) socket wrench to remove the two other lag bolts. Step 3: Repeat steps 1 and 2 for all four corners. (Figure 44 and Figure 45)

⚠ CAUTION

- ♦ Carefully remove all four brackets. Failure to do so might damage the cover when removing the crate sides.
- ♦ Flatten any protruding nails.

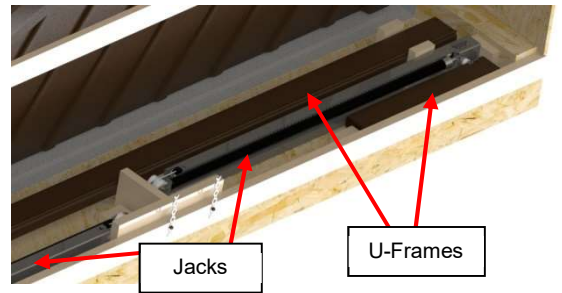

Figure 41

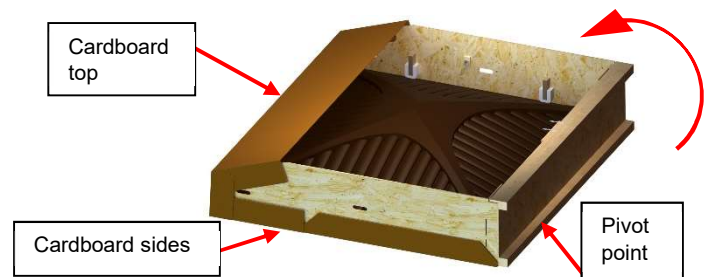

Figure 42

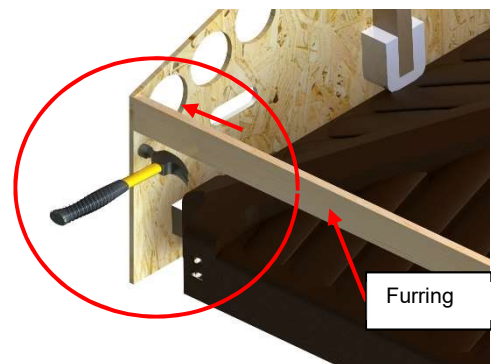

Figure 43

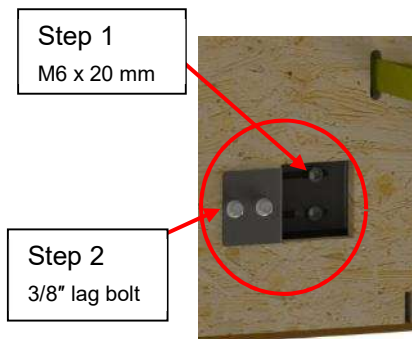

Figure 44



Figure 45

20) Use the Robertson screwdriver to unscrew the three #8-10 x 1½" screws holding both side panels to the bottom of the crate. (Figure 46)

⚠ CAUTION

- ◆ Remove side panels with care. The side panels could fall on the COVANA cover.

21) Pivot the side panels by gently prying them outward; lay the panels down on the ground. There is one panel per side. (Figure 47)

⚠ CAUTION

- ◆ Do not remove the side panels completely, doing so may damage the cover.

22) Pull the bottom section out, making sure that it does not interfere with the cover. If it does, gently lift the cover near the bottom section and continue pulling it out. (Figure 48)

⚠ CAUTION

- ◆ Do not flip the bottom section, this might scratch the COVANA cover if the nails are protruding from the wood. Pulling the bottom section is the best method to ensure no aesthetic damage.
- ◆ Flatten any protruding nails.



Figure 46

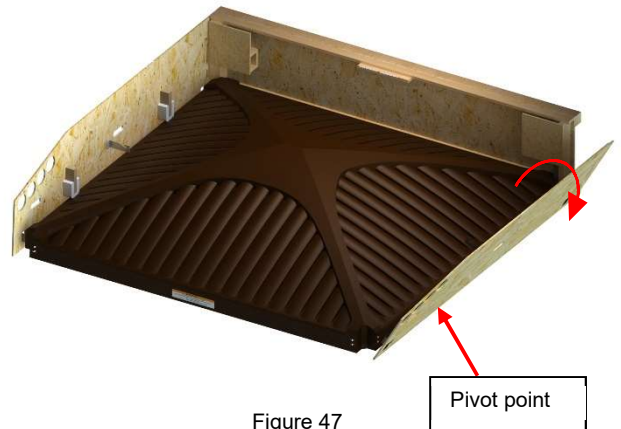

Figure 47

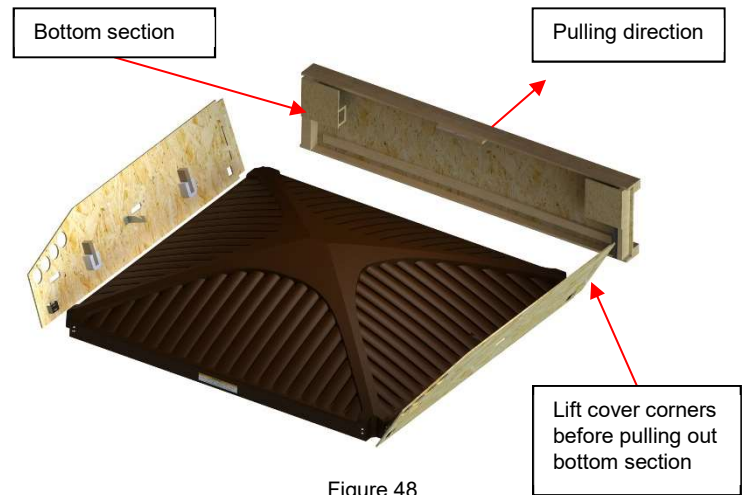

Figure 48

Assembly preparation

⚠ WARNING

- ◆ Before assembling, keep in mind not to overtighten bolts. Power tools **must not** be used. The bolts will break under too much torque.

- 1) Attach the installation foam to the top of the hot tub near each corner using the masking tape provided in the part box. There must be at least two foam spacers per side. Do not stack two pieces of foam one on top of the other. (Figure 49)

⚠ CAUTION

- ◆ The foam pieces must be placed on the flat top surface of the hot tub.
- 2) Place the top section of the COVANA cover on the hot tub and center it as best as possible. Measure your hot tub's dimensions and put the long side of the COVANA cover on the longest side of the hot tub. (Figure 50) If a LED light kit is included, the light switch should be placed on the entry side of the hot tub.

Note: The cover is rectangular. (Figure 50) The standard model will need the motor frame to be on the short side of the COVANA cover, whereas the long-side will need the motor frame on the long side of the COVANA cover.

⚠ WARNING

- ◆ The cover alone weighs approximately 185 lb. (84 kg).

⚠ CAUTION

- ◆ When handling the cover, both people must support the outer and inner shells with their hands. A wide grip is best when handling the cover, as all four sides must be lifted equally.
- ◆ 3 to 4 people may be required. If the COVANA cover is too heavy to handle, remove the outer shell. Be careful not to fold the outer shell or scratch it on the inner steel frame.

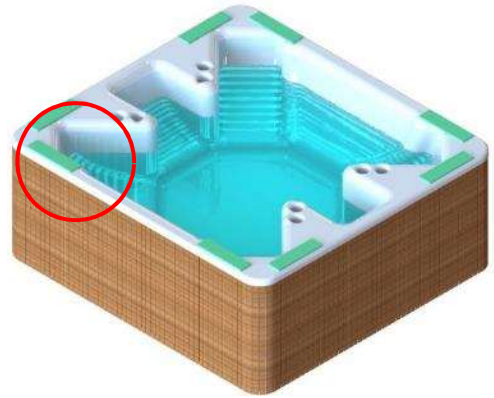

Figure 49

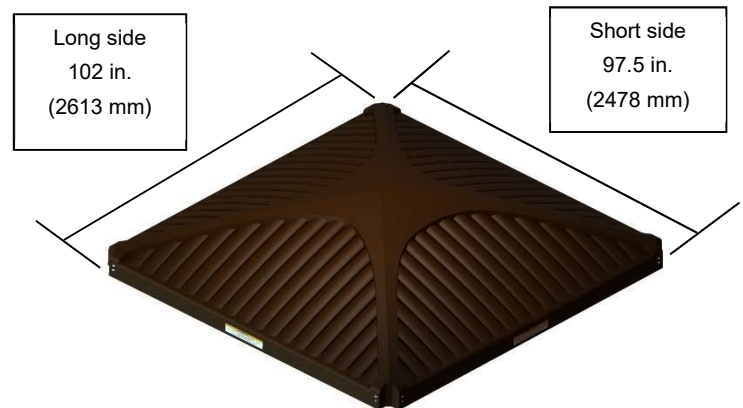

Figure 50

Lifting mechanism assembly

- Put the motor frame in place, usually to the back of the hot tub entrance. Place the motor frame according to Figure 51. The standard model will need the motor frame to be on the short side of the COVANA cover, whereas the long-side model will need the motor frame on the long side of the COVANA cover.

⚠ WARNING

- Do not remove the alignment bracket on the top of the jack.
- IMPORTANT: The steps that follow are side-specific.** The following steps are for the left-hand post foot assembly.
 - Install a first foot bracket to its non-motor-side jack. Make sure to align the foot bracket on the right side of the U-frame shaft as shown. (Figure 52)
 - Slide the alignment brackets of the foot in the alignment slots of the non-motor-side jack. (Figure 52 and Figure 53)
 - Push upwards to lock in place. Ensure full contact is made along the bottom plate. Using a rubber mallet may help lock it in place. (Figure 53)
 - Use the two 1/4"-20 x 2 1/4" hexagonal bolts, the nylon-insert lock nuts with the appropriate socket wrench spanner to fasten the assembly. **To prevent the mechanism from bending inward, do not overtighten these bolts. Make sure you respect the orientation of the fasteners, as shown.** (Figure 54)
 - For the right-hand non-motor-side jack assembly, repeat steps 3 to 6, putting the foot bracket on the left side at step 3. (Figure 52)

⚠ CAUTION

- Posts will fall easily when placed upright. Secure the posts by laying them down before proceeding with next step.

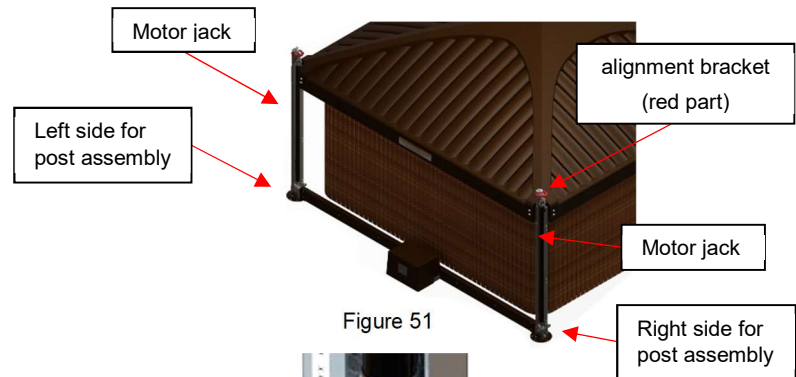

Figure 51

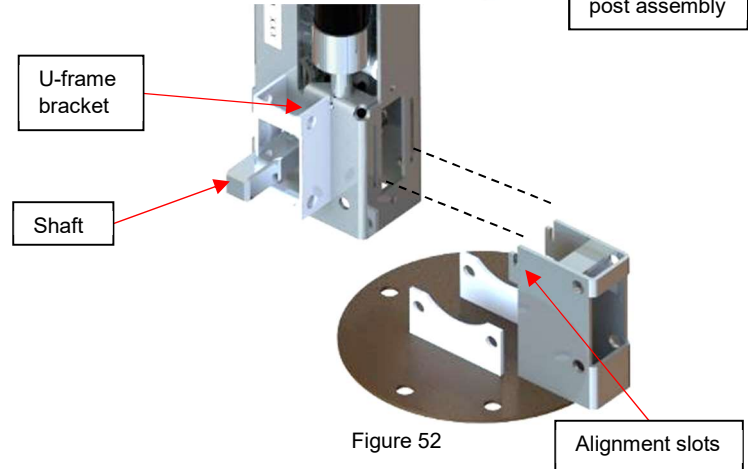

Figure 52

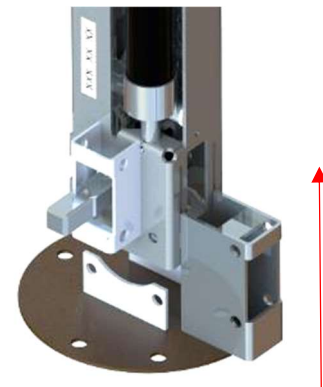

Figure 53

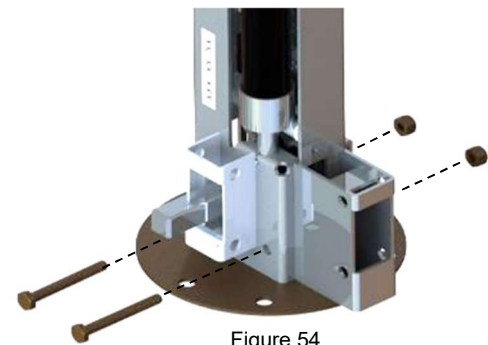

Figure 54

8) **Position the left non-motor-side jack** in the remaining corner of the COVANA cover. The square shaft at the bottom of the jack should face toward the motor frame, and the U-frame bracket should be inward. If not, review the previous steps to assemble the left and the right post feet.

9) Slide the drive shaft over the square shaft located at the bottom of the **left** motor-side jack assembly. (Figure 55) **Note:** The drive shafts are in the two long U-frames. Tear the plastic film to locate them.

10) Hold the left-hand non-motor-side jack assembly upright and in line with the left drive shaft. Use a 3/4" adjustable wrench to carefully rotate the square shaft of the jack so it aligns with the drive shaft. (Figure 56)

⚠ CAUTION

- ♦ Make sure the driveshaft is fully installed before proceeding further in the installation process. Using the jack without the driveshaft properly connected may cause injury.

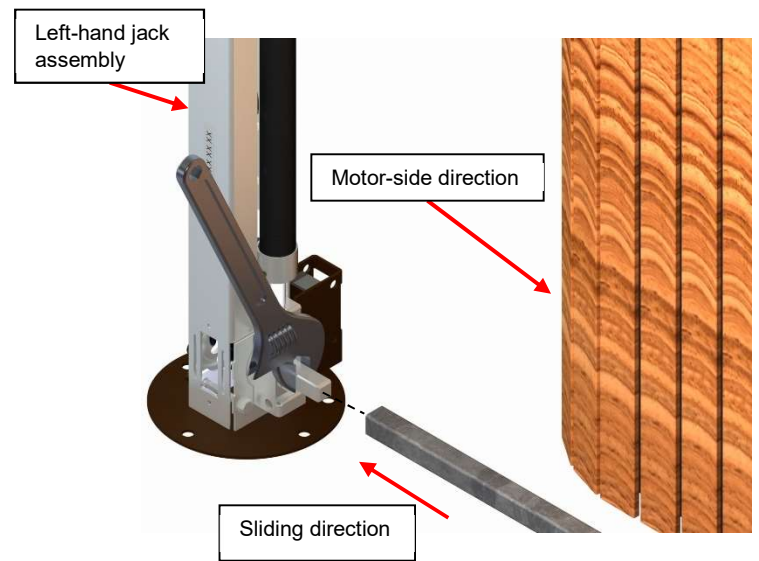
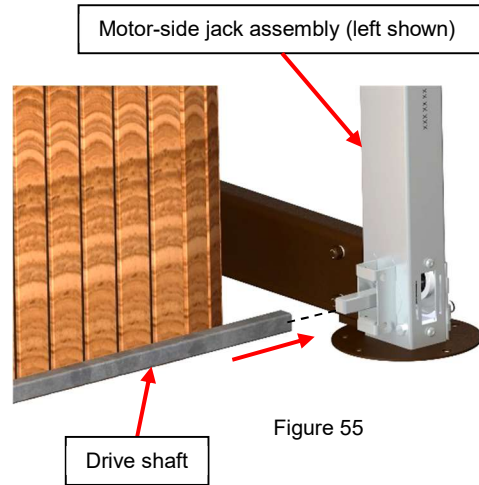

11) Install the long aluminum U-frame over the left driveshaft and ensure it lines up with motor-side and non-motor-side jack assemblies. Fasten it in place using two hexagonal 5/16"-18 x 2" bolts, two 5/16"-18 nylon-insert lock nuts and four 5/16" plastic washers per side. Use the 1/2" (13 mm) socket wrench and spanner as tool. **Do not fully tighten all bolts. The driveshaft may fall off during operation, and the re-assembling can be done faster when the bolts have not been fully tightened.** (Figure 57)

12) Perform steps 8 to 11 on the opposite side.

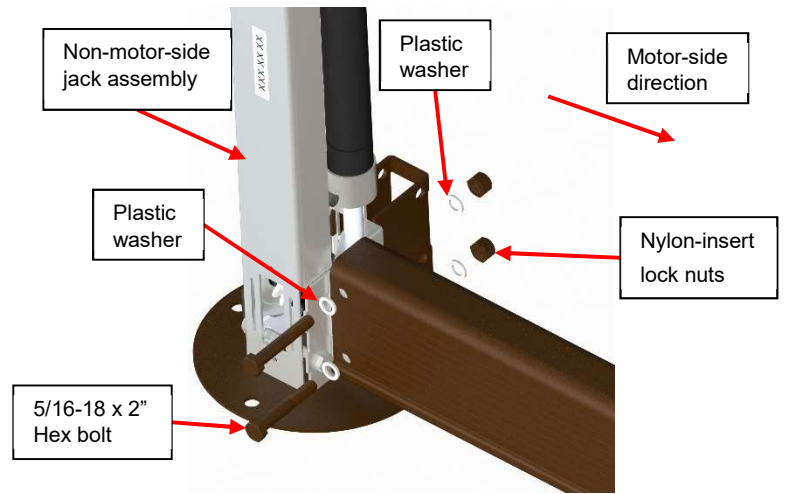

Figure 57

13) Install one unpainted metal coupler on each end of the front frame cut-out. (Figure 58)

14) Align one unpainted metal coupler with the holes on each end of the front frame cut-out. Use the provided 1/4"-20 x 3/4" carriage bolts, 1/4"-20 nylon-insert lock nuts and fasten the hardware with the 7/16" (11 mm) socket wrench and spanner. There is one metal coupler per side. (Figure 58)

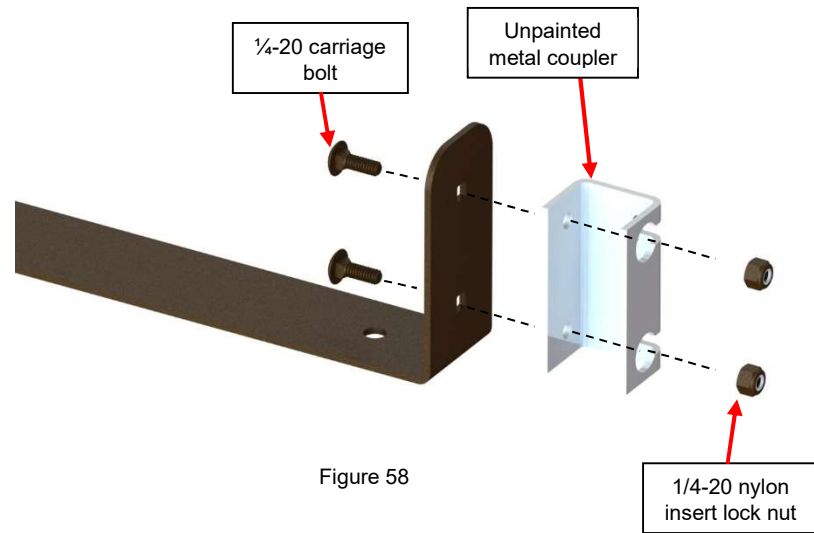

Figure 58

15) Fasten a short U-frame to each end of the front frame cut-out and then install the entire assembly between the front posts. Use four hexagonal 5/16"-18 x 2" bolts, four 5/16"-18 nylon-insert lock nuts and eight 5/16" plastic washers per side. Use 1/2" (13 mm) socket wrench and spanner. (Figure 59)

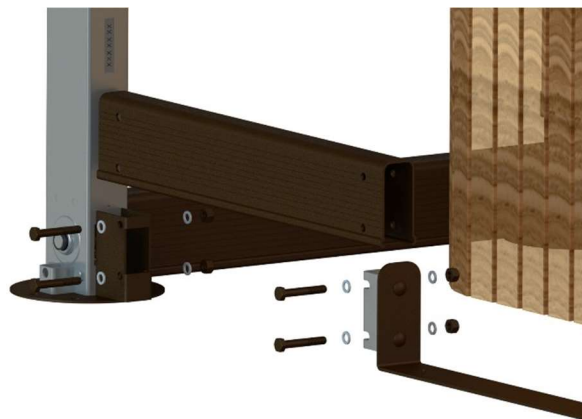

Figure 59

16) Verify whether the drive shafts fell off during installation. If so, review the previous steps. If not, tighten all U-frame bolts.

⚠ DANGER

- ♦ Failure to verify the proper installation of the drive shafts could result in the non-motor-side jacks extending on their own.

17) Once all drive shafts have been installed, the jack lock bolts located at the top of the non-motor-side jacks can safely be removed. Remove the Allen M8 x 50 mm bolts and **keep them for future use.** (Figure 60)

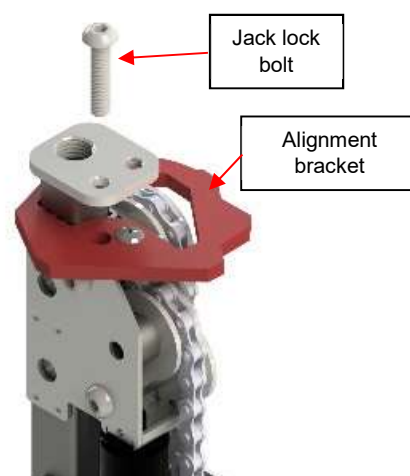

Figure 60

⚠ WARNING

- ♦ Failure to remove this part will break the lifting mechanism.
- ♦ **Do not** remove the alignment bracket on the top of the jack

18) Install the clip-on barrel nuts at the bottom of the non-motor-side jack assemblies for the sleeves, using Phillips M6 x 20 mm screws and 1/4" nylon washers. Only the non-motor-side jack assemblies need clip-on barrel nuts installed. (Figure 61)

NOTE: Do not fully screw in the M6 screws; a gap is needed to slip on the sleeves.

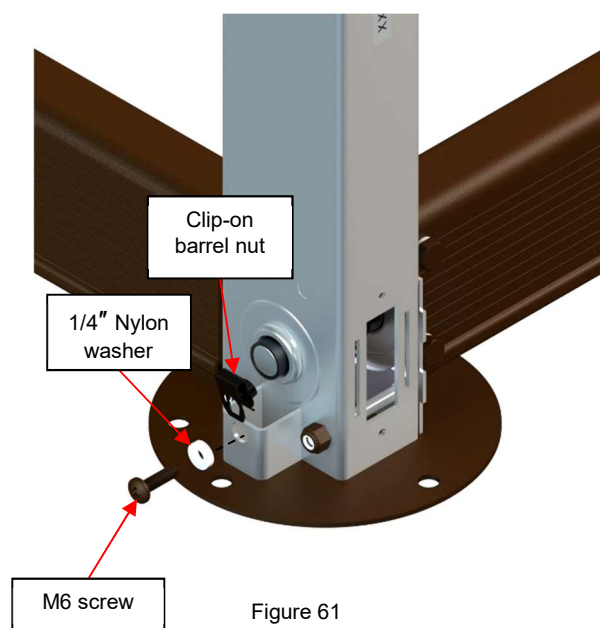

Figure 61

19) Unscrew the 3/8"-24 x1" Allen bolt with a 7/32" (5.5 mm) socket on the top of all four jack assemblies. Put these parts in a safe place.

20) Slide the sleeves over all four jacks. (Figure 62) Be sure to align the opening at the bottom of the sleeves with the U-frames attached. (Figure 63)

21) Screw in the Phillips M6 x 20 mm screws at the bottom of all four sleeves. (Figure 64)

⚠ CAUTION

- ♦ Be sure that the nylon washer is on the outside of the outer sleeve. (Figure 64)

22) Make sure the all-weather seal on each post is slid all the way down against the outer sleeve. (Figure 65)

⚠ WARNING

- ♦ Failing to properly position this part may cause serious damage to post mechanism.
- 23) Install the 3/8"-24 x1" Allen bolt with a 7/32" (5.5 mm) socket. The narrow part of the bushing faces down for each post. (Figure 66)

⚠ CAUTION

- ♦ Make sure that the wider part of the bushing is facing up when you screw in the 3/8"-24 x1" Allen bolt. (Figure 66)
- ♦ Ensure the hole in each top plate is aligned with the jack assembly's threads before installing the screw. (Figure 66)

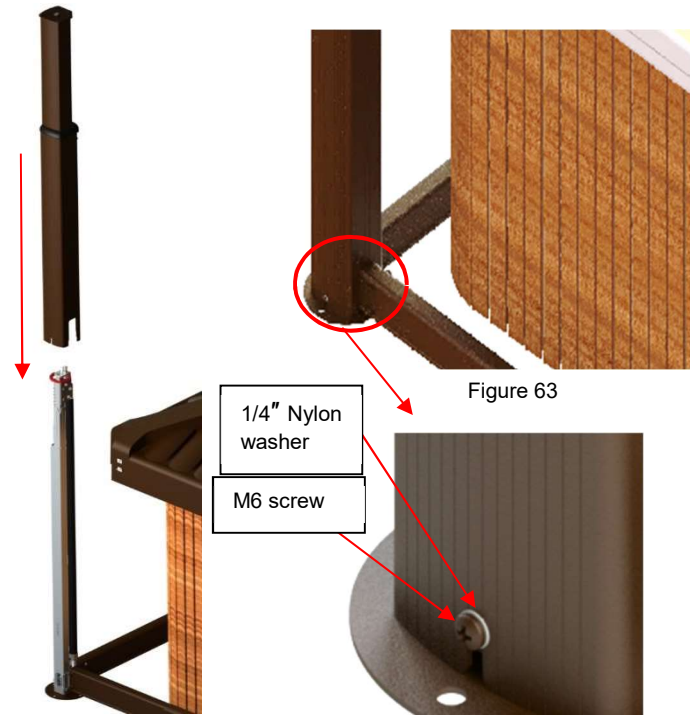
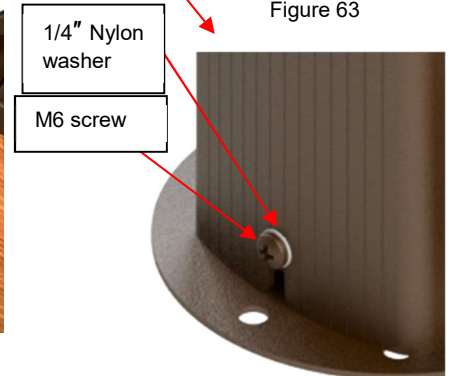

Figure 62

Figure 63



1/4" Nylon washer

M6 screw

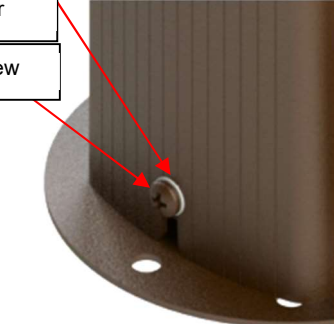

All-weather seal

Outer sleeve



Figure 65

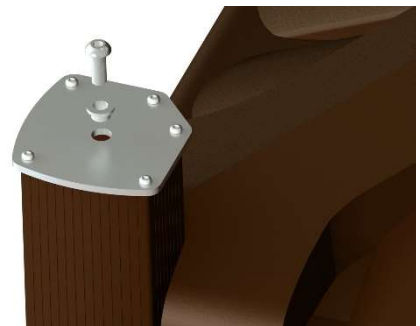

Figure 66

AC light kit installation

If your COVANA cover came with a light kit, follow the steps below. If not, skip to next section, *Lifting mechanism assembly (continued)*.

- 1) Before splitting the cover into two pieces, fully unscrew any bolts on all four corners that fasten the outer shell to the inner shell if needed.
- 2) Locate the light switch button. (Figure 67)
- 3) Lift and split the long side of the outer shell opposite the light switch button for the next steps. To split the cover into two parts, you must remove the outer shell by pushing inwards on the steel frame of the inner shell. (Figure 67 and Figure 68) This will clear the metal inserts from the outer shell for better leverage. **Do not lift more than 16 in (40 cm).**

Note: A non-abrasive or blunt tool may be used to help hold the outer shell in place before following the next steps.

⚠ CAUTION

- ◆ Do not use any sharp or abrasive tools to hold the outer shell in place while following the next steps.
- ◆ You should always hold the outer shell on the long side at two different points spaced by about 85 cm [34"]

⚠ WARNING

- ◆ Do not lift corner more than 16 in (40 cm), further lifting will damage the outer shell.
- ◆ Failure to follow this instruction will cause permanent damage to the outer shell.

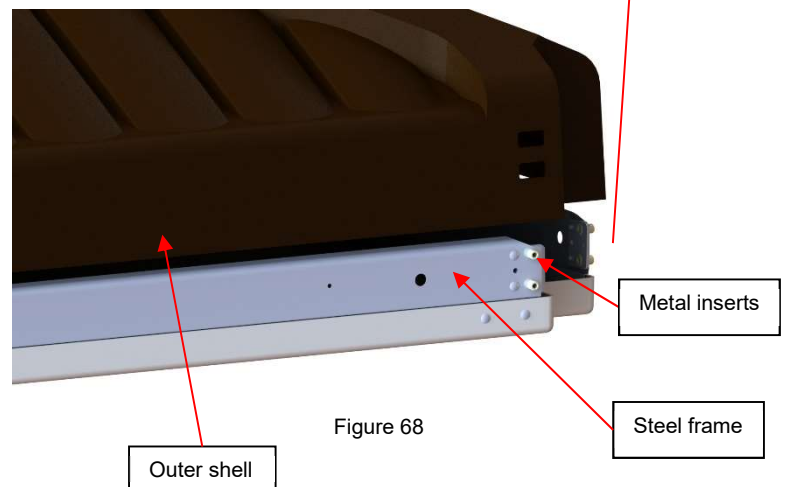
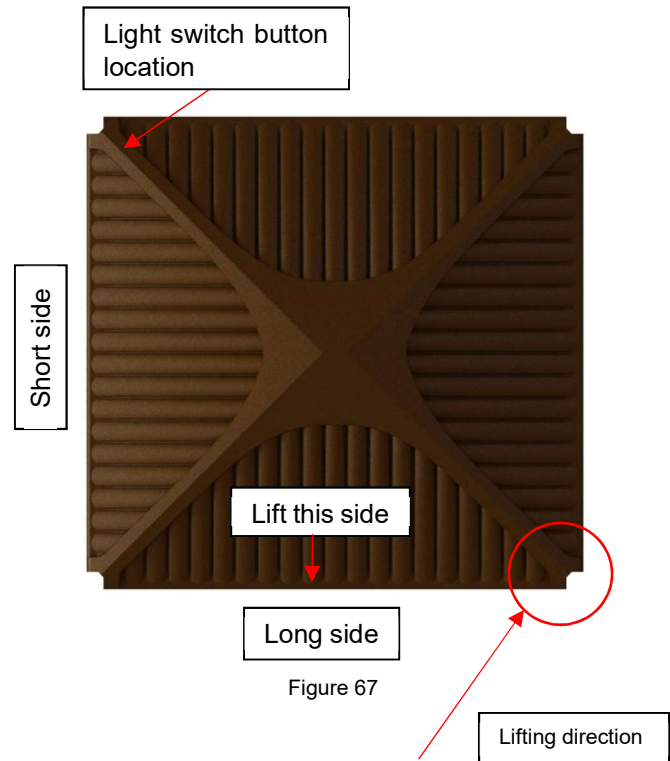

- 4) While holding the outer shell open, cut and remove the two cable ties that hold the wire guard. (Figure 69 and Figure 70)

⚠ WARNING

- ◆ Completely remove the cable ties, as they could interfere with the CTS-70 mechanism.
- 5) Open the wire guard by ripping the plastic off. There will be a plastic bag with two bottles of primer inside and an alcohol swab; put those items in a safe place.
 - 6) Gently place the wire guard outside of the inner shell. Let the wire guard hang down for the next steps.

⚠ WARNING

- ◆ Ensure the wire is clear of the inner and outer shells before proceeding. The wire should only hang from the inner shell hole. (Figure 70)

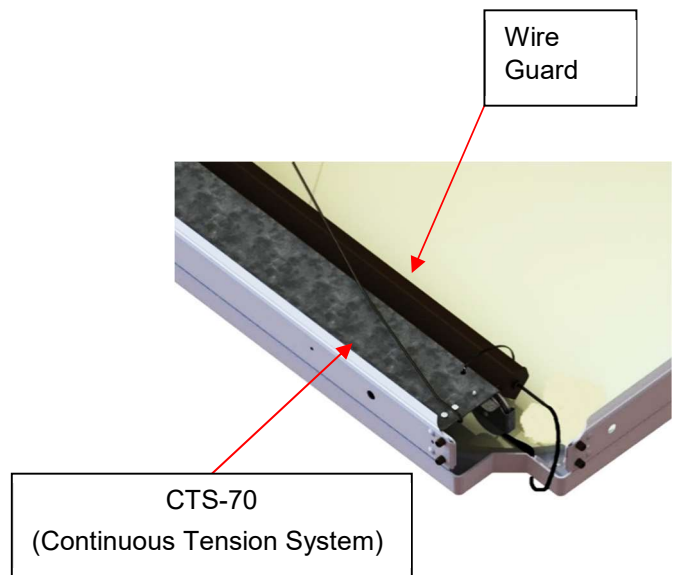

Figure 69

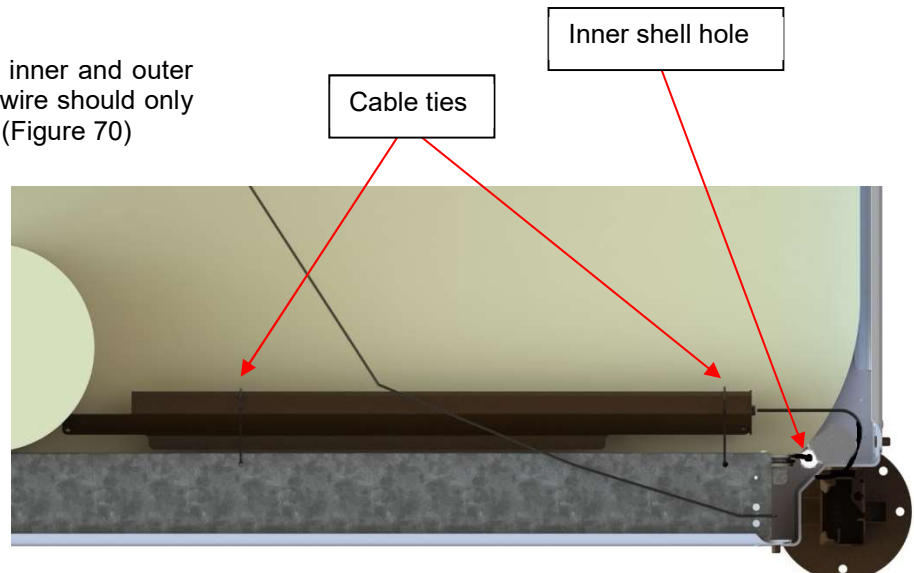
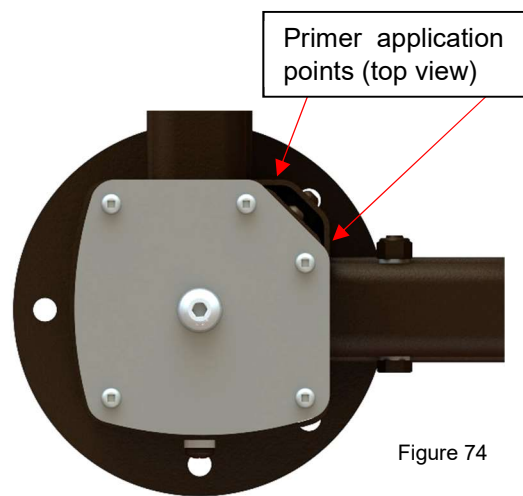
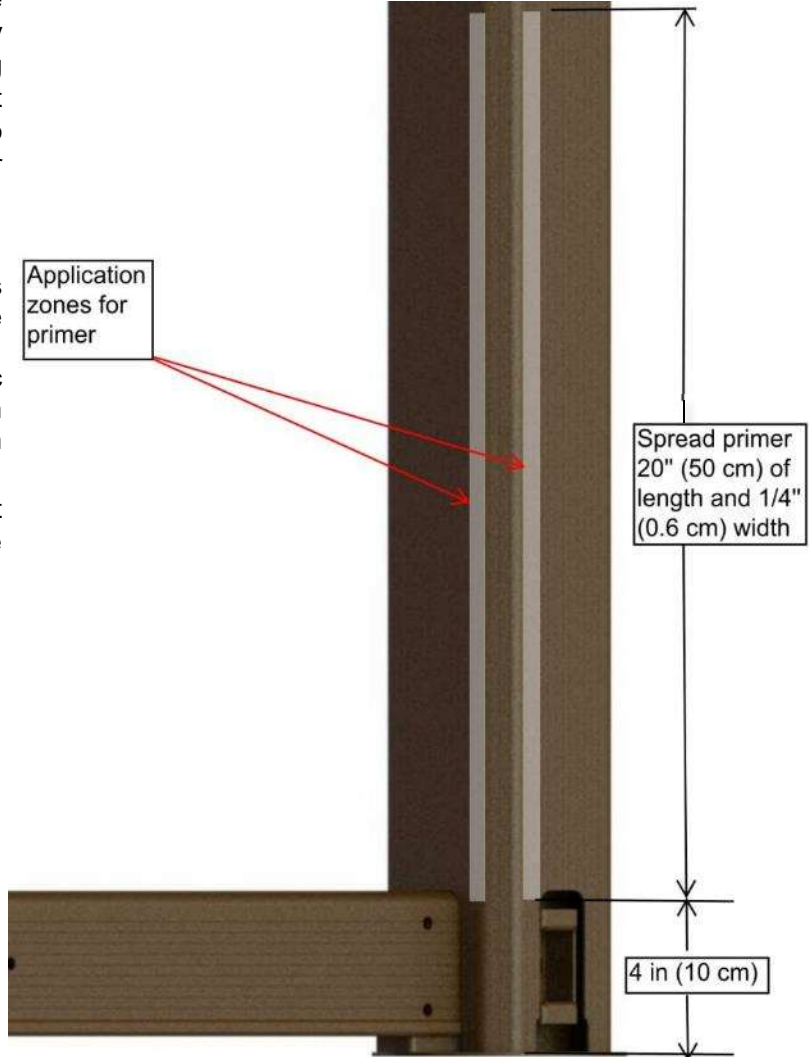
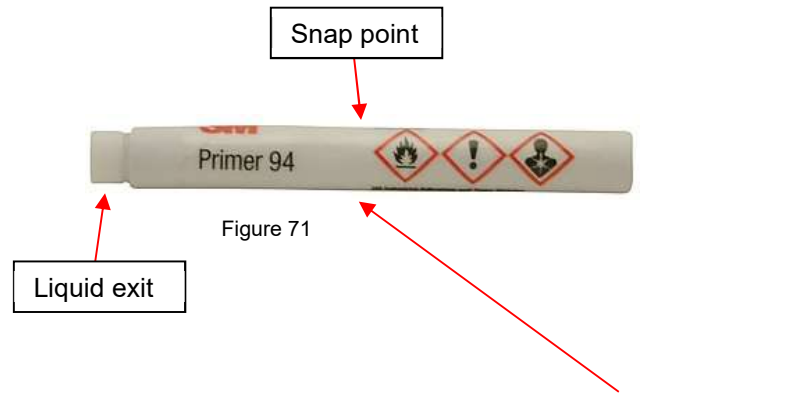

Figure 70

- 7) Clean the surface of the outer sleeve positioned on the opposite corner of the light button. Remove any dirt or contaminant and dry the surface (Figure 73).
- 8) Use the supplied alcohol swab and rub it on the surface of the outer sleeve positioned on the opposite corner of the light button to clean the surface. (Figure 73 and Figure 74). Wait two minutes for the alcohol to dry.
- 9) Apply the primer on the inside corner at the indicated areas. Refer to Figure 73 and Figure 74. The wire guard can also be held in place and taped off around its perimeter to mark off the application area. **Important:** Failure to apply the primer will result in the wire guard unsticking over a short period of time. The primer will act as the optimal bonding agent for the paint. To use the primer, snap the bottle in the middle for the liquid to come out. (Figure 71)

⚠ WARNING

- ♦ The bottle of primer (3M Primer 94) is considered flammable, a serious irritant for the eyes, a skin sensitizer, an inhalation hazard, toxic for reproductivity, carcinogenic and toxic for internal organs. Please be careful when handling the primer. Ensure proper ventilation prior to and during use.
- 10) Let the primer dry for at **least five minutes** at temperature above 40°F (5°C). This will ensure an adequate bonding surface.



- 11) Peel a small corner off the red plastic film on the double-sided tape, fold this tape toward the outside. (Do this step for both sides) (Figure 75)
- 12) Align and position the bottom of the wire guard against the foot plate that lines up with the inner shell hole. (Figure 77)

⚠ WARNING

- ♦ The bottom of the wire guard must be properly positioned on the foot plate. If not, review the previous steps. An improper alignment or positioning of the wire guard may cause the system to misadjust itself.

- 13) Fit the wire guard on the corner of the post. **Ensure no wires are pinched and that the wire guard is well levelled before adhering it to the sleeve.** (Figure 76 and Figure 77)

- 14) While still holding the wire guard on the post, gently start peeling away the red film one side at a time. This method will ensure proper alignment. Hold for **at least one minute** to ensure a proper bond. (Figure 78)

⚠ WARNING

- ♦ A good amount of pressure is needed to ensure that the wire guard band is properly on the sleeve.

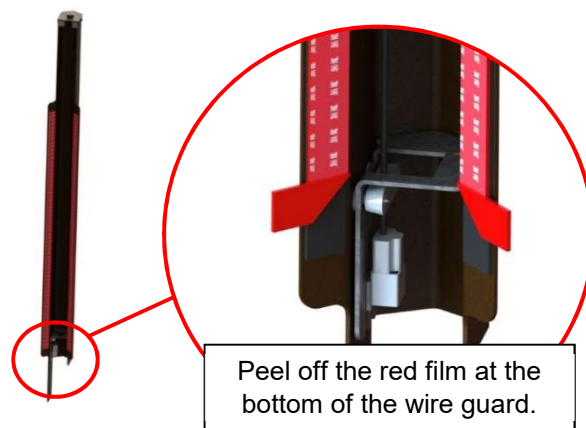

Figure 75

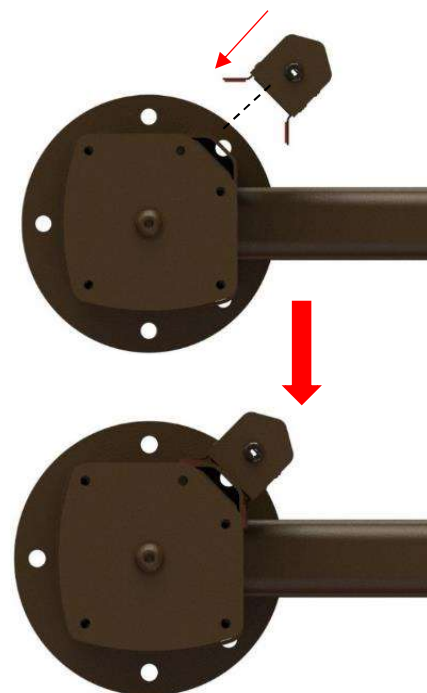

Figure 76

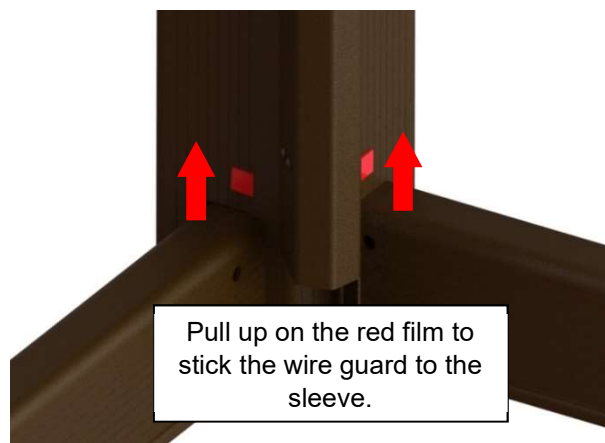

Figure 78

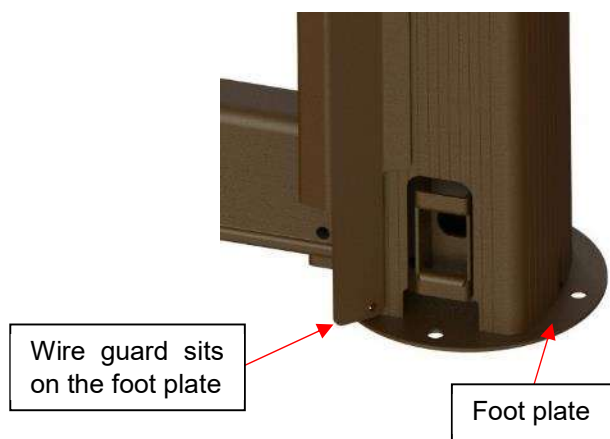

Figure 77

15) Now connect the bottom harness to the wire guard connector. The bottom harness is attached to the key switch cable. Cut the cable tie that holds the bottom harness. Connect it to the wire guard connector. (Figure 79)

⚠ WARNING

- ◆ Do not uninstall the wire guard connector. This could cause permanent damage to the wire harness.

16) *If your cover is completely lowered onto the hot tub, the exiting wire (Figure 81) seems to have sufficient tension and the magnetic plate is properly positioned (Figure 80), skip to next section, lifting mechanism assembly (continued). If not, follow next steps.*

17) Repeat steps 1 to 3 of this section for cover lifting instructions.

⚠ CAUTION

- ◆ Do not use any sharp or abrasive tools to hold the outer shell in place while following the next steps.

⚠ WARNING

- ◆ Do not lift corner more than 16 in (40 cm), further lifting will damage the outer shell.

18) Locate the set screws for the tension holder on the CTS-70 (Continuous Tension System). (Figure 81) Lightly unscrew them and pull back the tension wire until a slight resistance is felt. Once the resistance is felt, continue pulling another inch. Check the protruding wire going to the posts, and if the wire is tight enough, retighten the set screws.

19) Slide the outer shell back on the inner shell. The AC light kit has been successfully installed.

⚠ CAUTION

- ◆ When placing the outer shell back on, make sure that all the steel frames are inside the outer shell. Also, check all metal inserts before continuing. Failure to check these items may cause aesthetic damage.

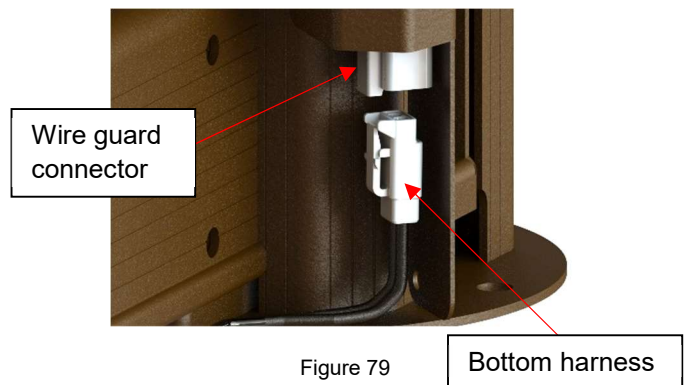

Figure 79

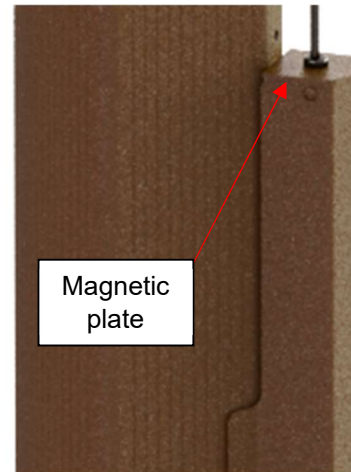

Figure 80

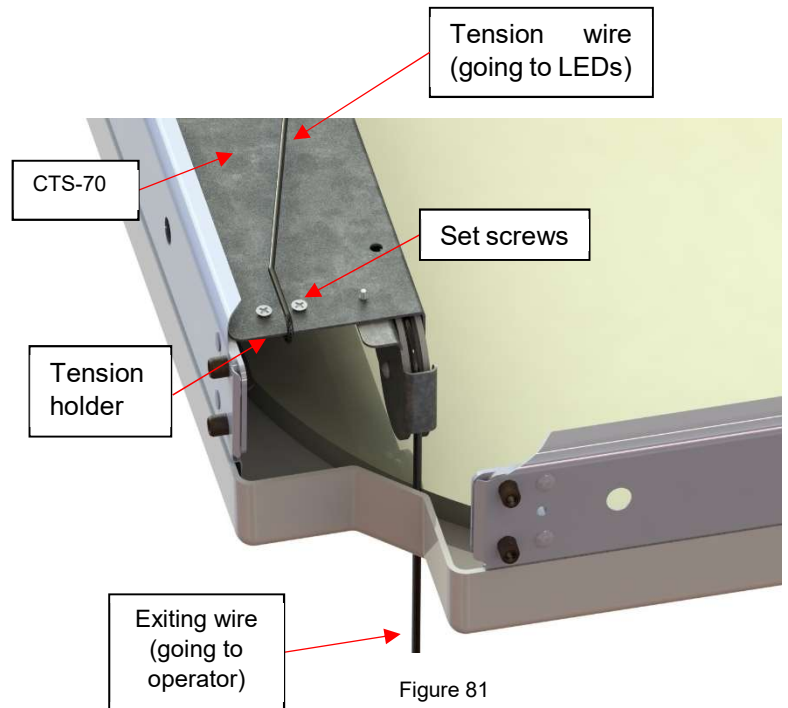

Figure 81

Lifting mechanism assembly (continued)

- 1) Ensure the COVANA cover is centered. Use a measuring tape on all four sides and make sure it is still resting on the foam spacers. If not, center the COVANA cover, using a measuring tape on all four sides.
- 2) Verify whether all the posts are vertically leveled with a 48" (122 cm) level. You will need to verify the front and right sides of each post with the level.
- 3) Install the first corner bracket (Figure 82). Fasten the bracket to the cover with four painted Phillips M6 x 20mm bolts and 5/16" painted washers.

⚠ WARNING

- ◆ Ensure the sleeve is correctly pressed against the outer shell before screwing in the M6 x 20 mm screws.

Note: Follow the patterns shown for installing the bolts (A to D). (Figure 82)

Note: We recommend placing the rounded edge of the corner bracket toward the top. (Figure 82)

- 4) Repeat step 3 for each remaining corner bracket, follow the order of installation as shown in Figure 83, 1 to 4.

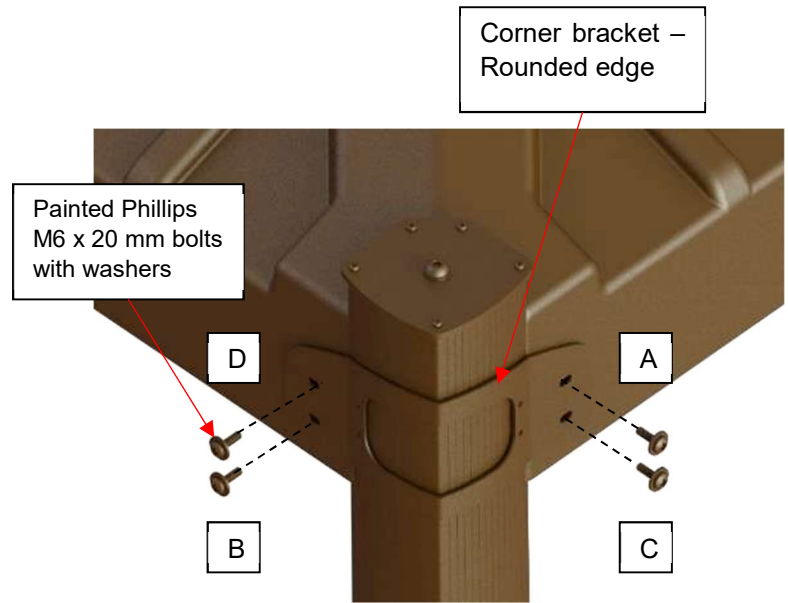

Figure 82

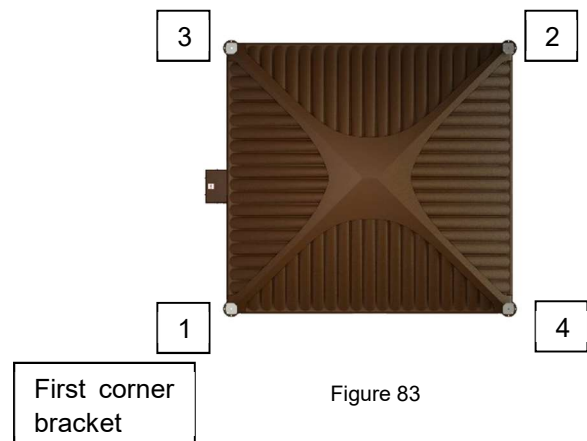

Figure 83

- 5) Then, use four #8 x 1/2" self-tapping Robertson screws to fasten one bracket to its post. (Figure 84) Tighten with care; self-tapping screws can break when screwed in too hard.

Note: Follow the pattern shown in Figure 85 (A to D).

Note: When fastening the screws, it is recommended to pull the post towards you for a better fit of the corner bracket. **This will diminish any possible gap.**

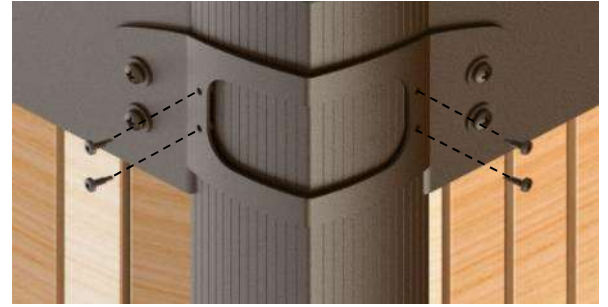
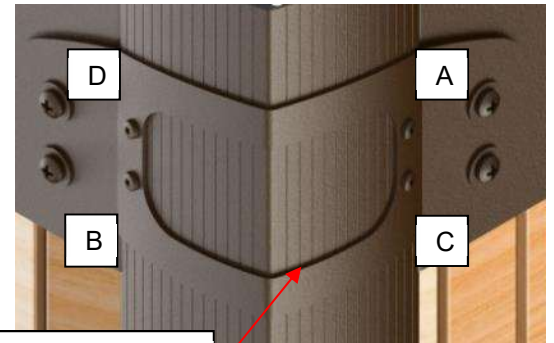

Figure 84

⚠ WARNING

- ♦ Make sure there is no gap between the sleeve and the bracket. If there is a gap, verify the previous step 5. (Figure 85)
 - ♦ Review previous steps before screwing in the Robertson screws; it is very hard to reposition the sleeves once they have already been screwed in. We highly recommend checking whether the posts are level before screwing in the corner bracket.
- 6) Repeat step 5 for the remaining brackets. Follow the same assembly pattern as shown in Figure 83 and Figure 85.



No gap should be present

Figure 85

- 7) Verify the installation of the brackets by trying to lift each **inner** sleeve. Review steps 3 to 6 for any broken screws or to retighten screws if an inner sleeve continues to move. (Figure 86)



Figure 86

- 8) Install the rubber caps on all four posts. These caps are in the parts box and help protect the post assembly tops from weathering. (Figure 87)

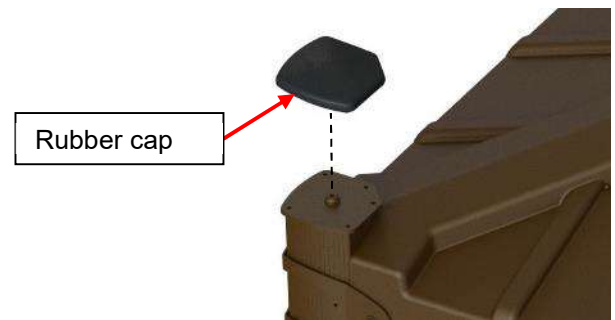

Figure 87

Testing the Oasis cover

- 1) Plug in the COVANA cover. **(Have a certified electrician complete the electrical hook-up and refer to the *Electrical Diagrams* section in the APPENDIX).**

⚠ WARNING

- ♦ All electrical connections must be done by a certified electrician.
- 2) Ensure there is no object directly above the cover or in its lifting path while performing this test. Refer to the instructions in the *Limit Switch Adjustment* section if adjustments are required.
 - 3) Use the key switch to lift it about 8 in (20 cm) and stop. Make sure the cover is lifting equally (no corners are higher than the others).
 - 4) Lower the cover down completely and make sure the cover is touching the foam pieces all around the hot tub perimeter.
 - 5) Lift the cover all the way up and pay attention for any unusual sounds (metal screeching or knocking). If so, consult the *Troubleshooting section* or contact your local dealer.
 - 6) Lower the cover and ensure it stops at the point of contact with all foam spacers on the hot tub. If not, adjust the corner brackets (follow steps 3 to 7 in the *Lifting mechanism assembly (continued)* section).
 - 7) Check whether the posts are still level before anchoring. Use the 48" (122 cm) level.
 - 8) Each of the four jacks on the COVANA cover must be properly anchored to the foundation using at least two of the pre-drilled holes located on the cover of each post. (*Anchors not supplied*) (See section *Foundation preparation*).

- 9) The optional non-permanent mounting plates can be used when anchoring is not possible. **They are not designed for windy areas.**

⚠ WARNING

- ♦ The non-permanent mounting plates can only be used in areas with low winds.
- ♦ The non-permanent mounting plates must be properly installed. (*See non-permanent mounting plates installation section.*)

- 10) Permanently mount the key switch. The key switch must be located 5 ft (1,5 m) away from the hot tub and 5 ft (1,5m) above the deck or ground lever. (Figure 22) Ensure the user has a clear view of the COVANA cover when operating it. **Cut the power when installing the key switch.**

⚠ CAUTION

- ♦ When operating, the user must always have a clear view of the COVANA cover and its surroundings.

⚠ WARNING

- ♦ Failure to permanently install the key switch as indicated could cause serious injury or even death and void the warranty and certification. Only proper installation of the key switch combined with the suggested procedures and caution will reduce such risks.
- ♦ Ensure that the base of the COVANA cover is not in a flood zone. Any damage caused by flooding or water accumulation will not be covered under the warranty.
- ♦ The key switch terminal should be located in a place where no water or debris could fall on it.

Non-permanent mounting plate installation

Note:

This setup is only available for hot tub base sizes larger than 82" wide for Standard COVANA Units and 87" wide for Long Side COVANA Units.

- 1) After the unit has been installed, but BEFORE installing the seal, proceed with the non-permanent mounting plate installation. Using the key switch, lift the COVANA cover up to give room for handling the tub.
- 2) **Note:** Three installers are required. Two should lift the tub at one end approx. 4" off the ground while the third slips the non-permanent mounting plates under the hot tub and hooks them over the U-Frame. (Figure 88 and Figure 89).
- 3) Repeat on the other side as shown on Figure 88. **Note:** The plates must be installed over the U-frame (two on each side).
- 4) The proper disposition of the plates is determined by the size of the hot tub. You normally want the plates to be as close to the corners of the tub as possible. (Figure 89)
- 5) Once the plates are under both sides of the hot tub and once they have been properly positioned over the U-frames, you may continue with the seal installation.

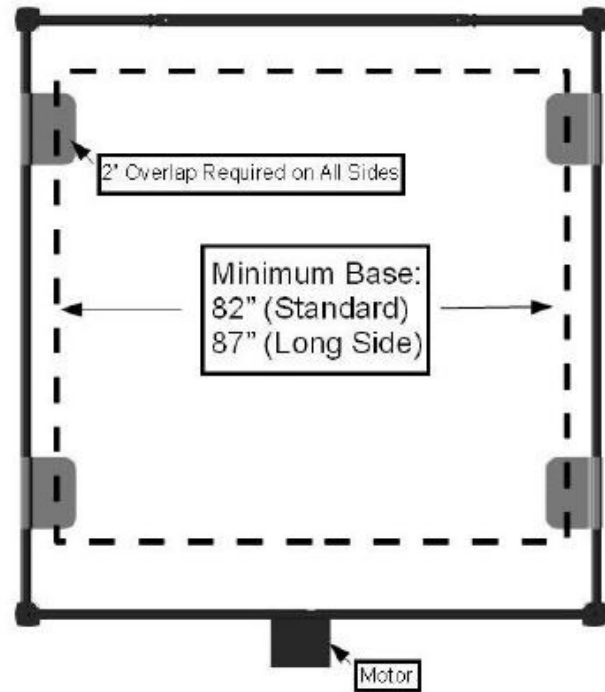

Figure 88

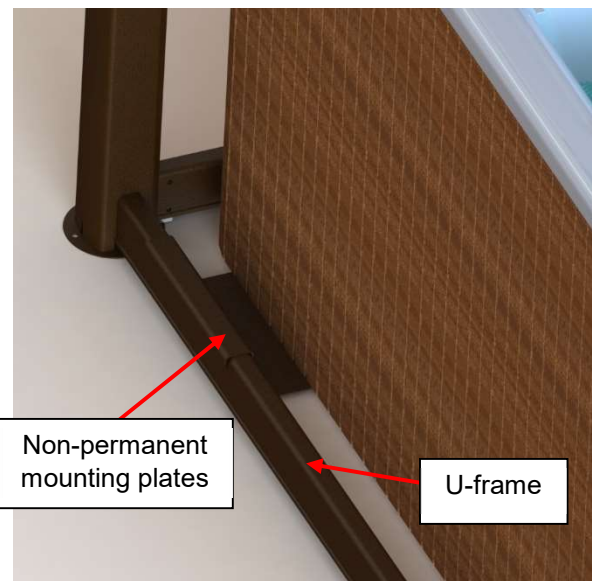

Figure 89

Seal application

- 1) Once the COVANA cover has been fully assembled, raise the cover and remove the foam spacers and tape. Lower the cover and walk around the entire perimeter of the spa, observing where the inside surface of the cover will make contact with the spa. This will determine the best location to apply the seal.

⚠ CAUTION

- ◆ It is recommended to perform the seal installation when the ambient temperature is above 50°F (10°C).
- ◆ Before installing the seal joint, it is strongly recommended to reduce the water vapour generated by the spa. To do this; stop the agitation of the water by stopping the recirculation pump, and then set the temperature of the spa water to be between 2 and 5 degrees above ambient temperature.

- 2) Dry the spa edge and the underside of the cover with a clean cloth.
- 3) Apply the provided masking tape around the spa where the seal will be installed. The masking tape will ensure the seal is straight when pulled corner to corner. The ideal location for the seal is closer to the spa's interior edge, but on a flat surface (Figure 90). The minimum turn radius for the seal is 4" (10 cm).

⚠ WARNING

- ◆ The use of masking tape is recommended since it will protect the acrylic tub from the clips' glue. Furthermore, pulling the masking tape from one corner to the next will ensure straightness.
- 4) Apply the provided seal clips parallel to the masking tape around the spa and make sure there is more in the corners and in any tight turns (around filters, etc.). Keep in mind that a limited number of clips are provided. Install two clips where the seal joint connector will be located (Figure 90 and Figure 91).
 - 5) Start installing the seal joint on the opposite side from the entrance of the spa (where the two clips were installed for the seal joint connector), with the adhesive layer facing up toward the cover (Figure 91 and Figure 92)

⚠ CAUTION

- ◆ Do not install the seal joint near a control system or the critical components of the spa.

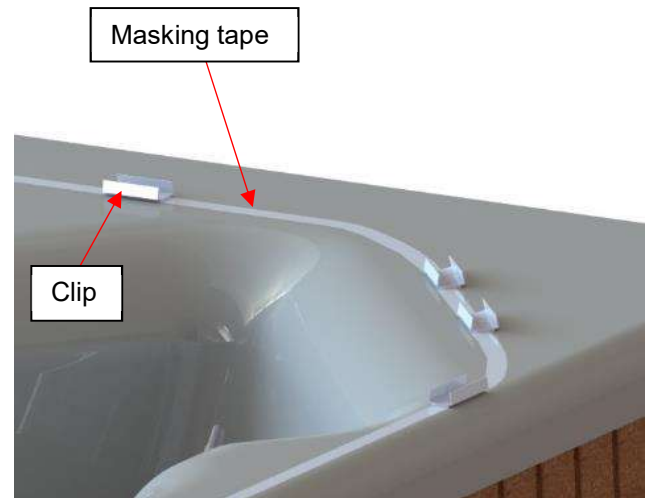

Figure 90



Figure 91

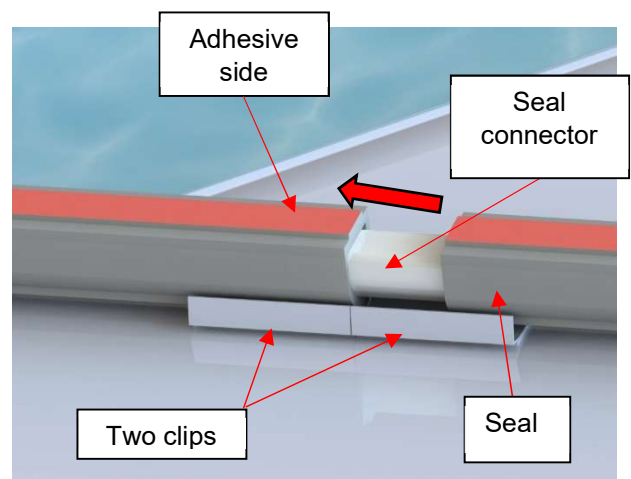

Figure 92

- 6) Once the seal is installed around the entire spa, you must cut the extra length as straight as possible for the best joint finishing results.
- 7) Use the supplied seal connector and insert it in both ends of the seal. The use of masking tape to hold the two ends tightly together is recommended (Figure 92).

⚠ WARNING

- ◆ At this point, if there is no water in the spa and the ambient air temperature is below 50°F (10°C), a temporary heater must be placed inside the spa for about 10 to 15 minutes. Once the heater is in the spa, lower the cover until it touches the seal to increase the air temperature. While generating heat, regularly check interior air temperature and do not let it reach temperatures above 40°C. After 10 to 15 minutes, remove the heater and continue with the seal installation. The rubber seal should not be overheated. Do not directly heat the acrylic or seal, as this may cause permanent damage. Do not place the heater too close to the acrylic surface, as the surface could melt or catch fire. Place the heater on a pedestal or spacers so it will not rest directly on the acrylic tub. The heater can be put back in place after step 15) and used if necessary during the curing period specified in step 16).
- ◆ Ensure that the air temperature in the spa is still between 20°C and 40°C before proceeding to step 8).
- ◆ Remove all dirt, oil residues and moisture from the underside of the cover for proper seal adhesion, especially in wet spa installations. The use of mild detergent can help clean the surface.
- ◆ Ensure the seal stays tight in the clips to ensure its proper positioning.

- 8) Test the seal placement by lowering the cover about ¼" (6 mm) over the seal to ensure that the entire perimeter **will make contact** with the seal. If you are satisfied, raise the cover and remove the red plastic backing off the seal.
- 9) Completely lower the cover onto the seal. Leave the cover in this position for **at least 5 minutes** to ensure proper seal-to-cover adhesion.
- 10) Slowly raise the cover no more than a 1/4" (6 mm) and leave the cover in this position for about 10 seconds, as this will allow the seal to slowly and fully release from the seal clips. You can also use a non-abrasive plastic tool or your fingers to help release the seal.
- 11) Once satisfied that the seal is released, raise the cover 36" (91 cm) high. Apply pressure on the seal to properly bond the adhesive to the underside of the cover. To apply pressure to the seal, simply push it against the COVANA cover with your hands.
- 12) Remove the seal clips and tape from the tub's edge.
- 13) Lower the cover again at approx. 6" (15 cm) from the spa and stop.
- 14) Ensure the cover is flat and there are no corners higher than the others.
- 15) Lower the cover again, and ensure the seal is touching the spa all around it.
- 16) Completely lower the COVANA cover and leave it closed for **at least 24 hours**. This will ensure the seal is properly bonded to the cover surface.
- 17) The seal installation is completed.

ELECTRICAL HOOK-UP

Avoiding the risk of electrocution

⚠ CAUTION

- ◆ All electrical work should be done by a qualified electrician, otherwise the certification and warranty will be voided. Furthermore, any modifications to the electrical components will also void the warranty.

⚠ ELECTRICAL DANGER

- ◆ Failure to comply with these instructions may result in death by electrocution or serious injury. Disconnect or turn off and secure all power supplies before starting an intervention on the COVANA cover.
- ◆ *For AC-operated model:* A disconnect mean needs to be incorporated into the fixed wiring at the time of installation. This mean must be accessible to the user or service technician to turn the power off for future maintenance or repair.
- ◆ Always have a licensed electrical contractor perform any electrical maintenance or repairs on the COVANA cover. The wiring must comply with all applicable local electrical codes and regulations.
- ◆ The COVANA operator must be connected to a circuit that is protected by a dedicated GFCI that complies with all applicable local electrical codes and regulations.
- ◆ Install the COVANA cover in such a way that drainage directs water away from the electrical components.

- ◆ Do not connect any auxiliary components to the electrical system of the COVANA cover unless they have been approved by COVANA.
- ◆ Replace electrical components with original components provided or approved by COVANA. Ask your dealer for replacement parts.

⚠ ELECTRICAL WARNING

- ◆ To reduce the risk of electric shock, the green-colored terminal or the terminal marked “g,” “gr,” “ground,” “grounding” or with the \perp symbol that is located inside the supply terminal box or compartment must be connected to the grounding mean provided in the electric supply service panel with a continuous copper wire equivalent in size to the circuit conductors supplying the equipment.
- ◆ Two lugs marked “bonding lugs” are provided on the external surface or on the inside of the supply terminal box or compartment. To reduce the risk of electric shock, connect the local common bonding grid in the area of the COVANA cover. Use terminals with an insulated or bare copper conductor no smaller than No. 6 AWG (13.30 mm²).

⚠ ELECTRICAL CAUTION

- ◆ All field-installed metal components, such as rails, ladders, drains or other similar hardware, within 10 ft (3 m) of the hot tub must be bonded to the equipment grounding bus with copper conductors no smaller than No. 6 AWG (13.30 mm²).

Grounding and power supply connection

- 1) Remove the four screws on the bottom side of the COVANA operator and remove the cover. (Figure 93)
- 2) Refer to the complete wiring diagrams for the European or North American models in the appendix.

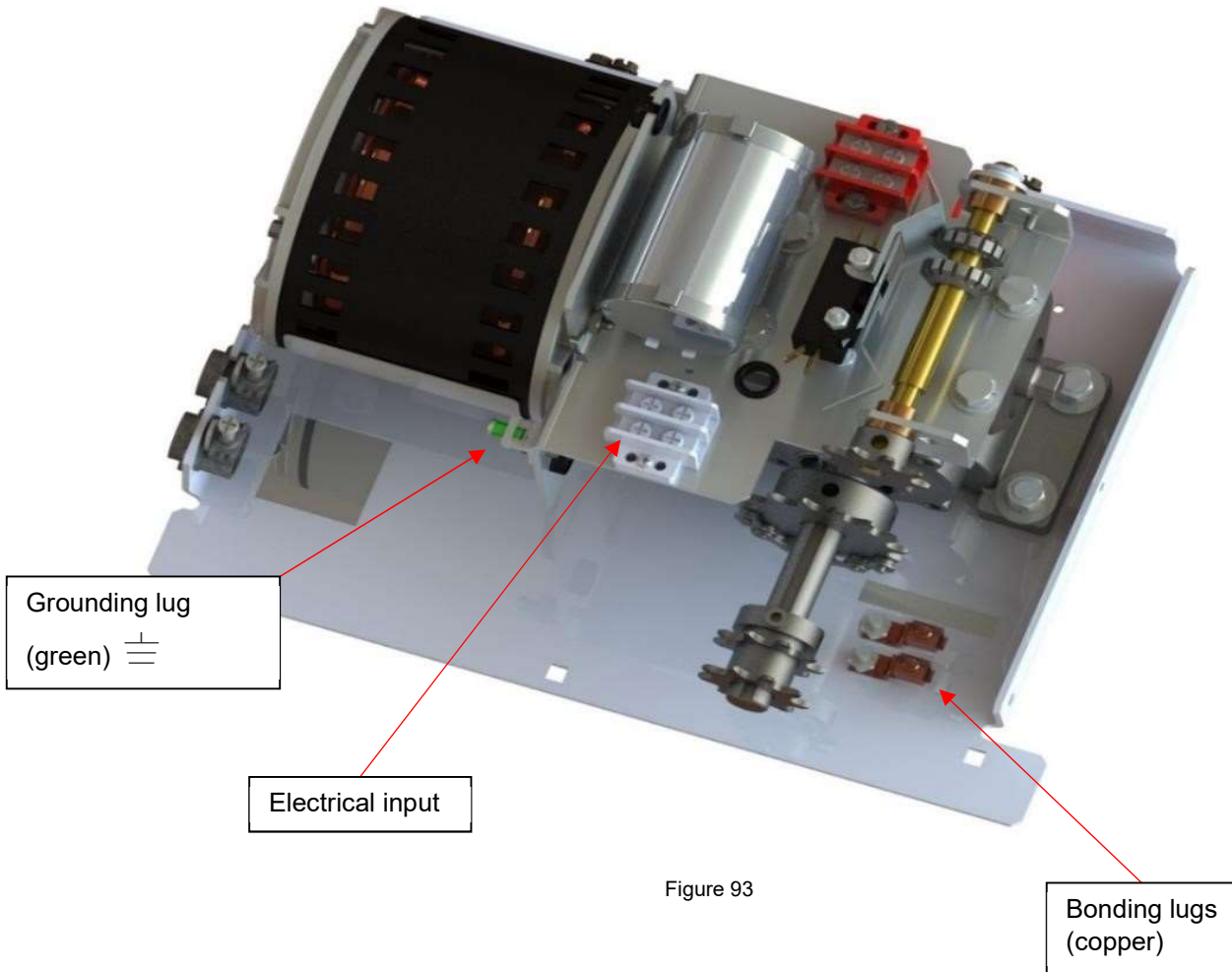

Figure 93

TECHNICAL SPECIFICATIONS

Side elevation

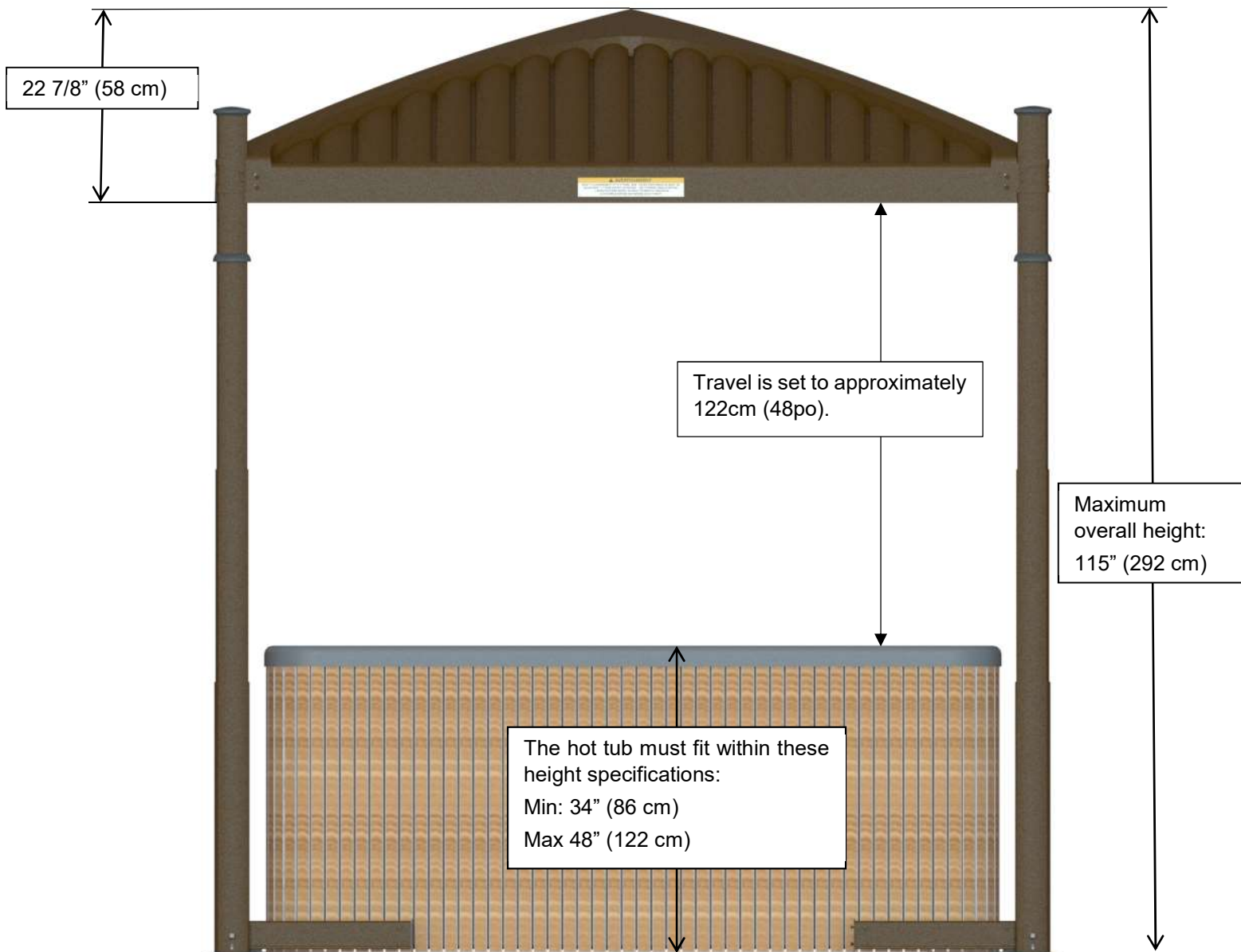
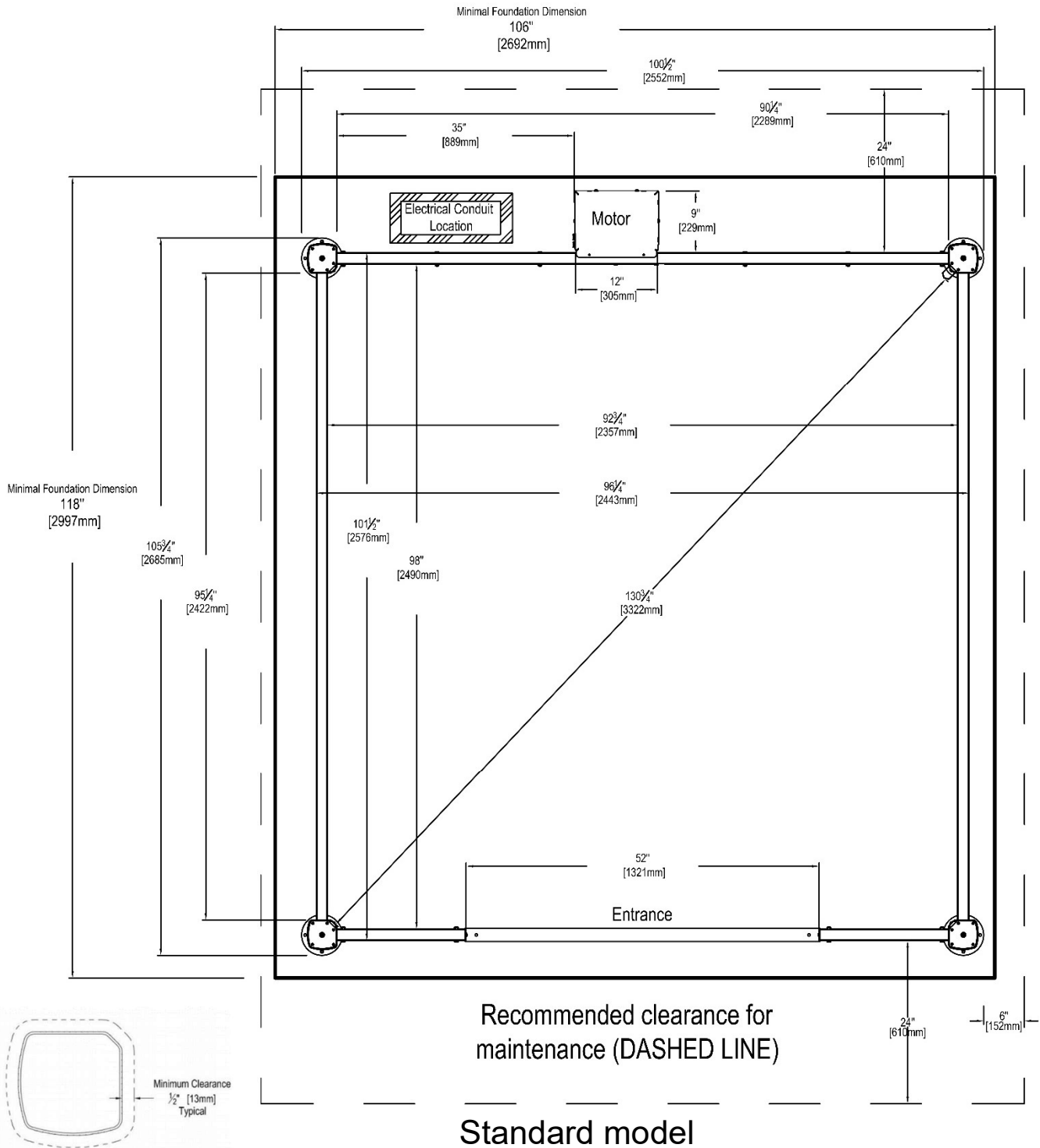

Figure 94

Frame dimensions and foot print



If the frame installation is below a deck, the required minimum post to deck clearance

Figure 95

****NOT TO SCALE****

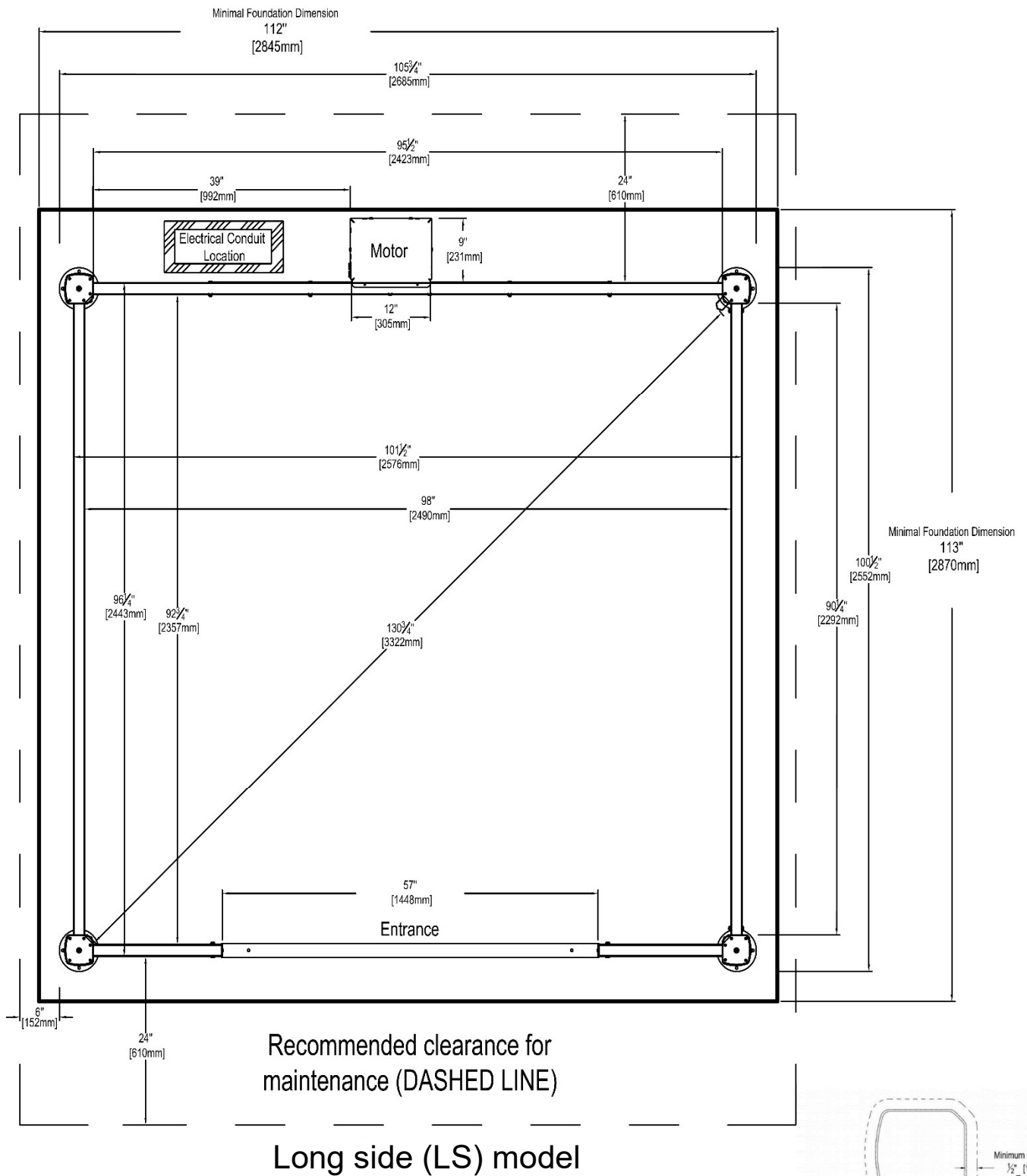

Figure 96

****NOT TO SCALE****

If the frame installation is below a deck, the required minimum post to deck clearance

Electrical specifications

- ♦ The COVANA Oasis cover requires a dedicated single-phase 115 V AC (North America) or 220 VAC (Europe) hard-wired power supply.
- ♦ The COVANA Oasis cover must be installed in accordance with and comply with all applicable local codes and regulations. All wiring and connections should be performed by a qualified electrician.
- ♦ Wires and conduits should be sized according to local codes and regulations.

North American requirements:

Voltage	115 V, 60 Hz (1 hot, 1 neutral, 1 ground)
GFCI	15 A single-pole GFCI (not included)
Current draw	Max 12 A

European requirements:

Voltage	220 V, 50 Hz (2 hot, 1 ground)
GFCI	10 A single-pole GFCI (not included)
Current draw	Max 6 A

⚠ WARNING

- ♦ COVANA does not allow any modifications of the electrical system. COVANA reserves the right to void the warranty if any modification is done without its specific approval.

Operating limitations

⚠ WARNING:

- ♦ The COVANA cover should never be used if the following conditions are reached.

Maximum wind	Gusts of 30 mph (50 km/h) in the raised position and 45 mph (70 km/h) when completely lowered on the hot tub.
Maximum weight on the cover (evenly distributed)	200 lb. (90 kg)

* The load specification for the OASIS cover is a provision for environmental outcomes, typically some snow or damp leaves that could accumulate on the cover.

General specifications

Lifting speed	2.5 in./s (6 cm/s)
Total weight	600 lb. (272 kg)
Stock key switch cable	25 ft. (7.6 m)

LIMIT SWITCH ADJUSTMENT

ELECTRICAL WARNING

- ◆ Disconnect or turn off the power supply before starting any work on the COVANA cover. Additionally, all electrical work should be performed by a qualified electrician.

Note: The up and down limit switches have been factory-adjusted and there should be no need to re-adjust them. If adjustments are required to ensure the COVANA cover does not come in contact with surrounding obstacles while being raised, the maximum height may be reduced. Never change the factory setting of the down limit nor increase the up limit beyond the factory setting. Failing to do so may result in equipment damage and/or injury.

- 1) Disconnect or turn off the power and lock out the power source.
- 2) Remove the four slotted screws at the bottom of the operator and remove the cover. (Figure 97)
- 3) Remove the slotted retaining screw and slide the cam plate out from operator frame. (Figure 98) (Be careful not to move the cam wheels.)
- 4) To reduce the amount of travel in the upward direction, turn the up-cam wheel counter clockwise viewed from the cam plate as shown. (Figure 99) When turning counter-clockwise, for each cam wheels' lot travel (approx. 4°), the upper cover limit will be reduced by approximately 5/32 in (4 mm).
- 5) Once the height is set to the desired position, return the cam plate to its original position and ensure that it is properly inserted in the slot of each cam. **Never operate the system without the cam plate and retaining screw.** (Figure 99)
- 6) Reinsert the slotted retaining screw to prevent the cam plate from coming out.
- 7) Reinstall the operator cover.
- 8) Turn the power on and test the system.
- 9) Screw the cover back on using the 4 slotted screws. (Figure 97)



Figure 97

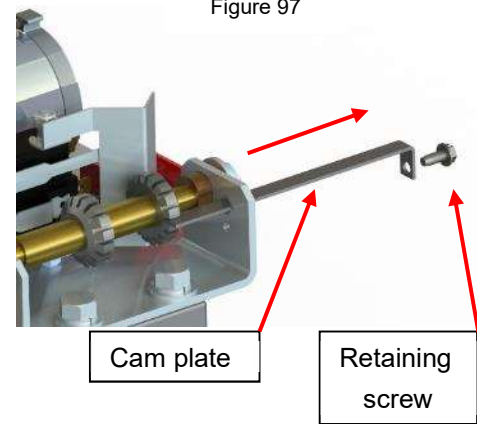

Figure 98

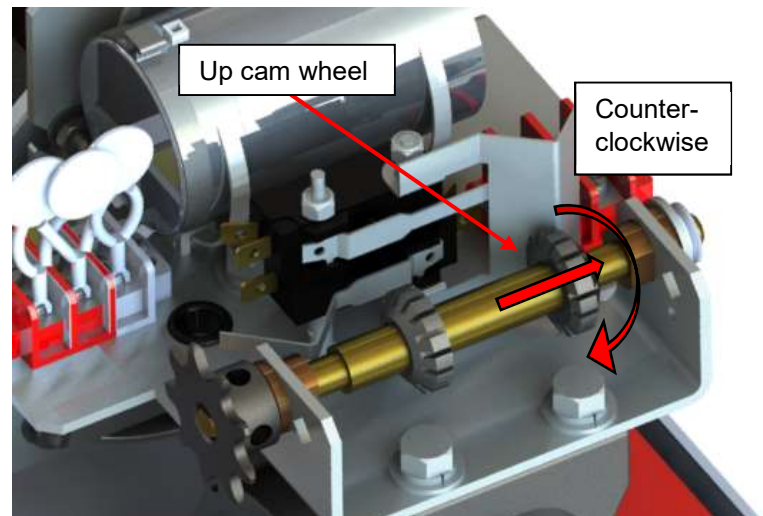

Figure 99

TROUBLESHOOTING

Problem	Probable Causes	Solutions
COVANA cover does not raise or lower. (Silent motor and no movement)	<ul style="list-style-type: none"> ♦ The GFCI is tripped. ♦ The power source is disconnected. 	<ul style="list-style-type: none"> ♦ Reset the GFCI. ♦ Check that the power source is enabled. ♦ Check the breaker panel. ♦ Check if any electrical cables are damaged or pinched.
COVANA cover does not raise or lower. (Motor humming and some visible movement)	<ul style="list-style-type: none"> ♦ Posts are frozen. ♦ Cover is obstructed. ♦ Jack assemblies are jammed. ♦ Motor is obstructed. ♦ Posts are obstructed. 	<ul style="list-style-type: none"> ♦ Remove all debris from top of COVANA cover. ♦ Check if posts are obstructed. ♦ Use methanol to free ice buildup on posts. ♦ Grease the jack assemblies. * ♦ Check the relative position of the four posts. (See <i>Foundation preparation</i> section on installation manual) ♦ If all previous attempts failed, contact your local authorized COVANA dealer. *
Lights do not work.	<ul style="list-style-type: none"> ♦ The lighting assembly is faulty. ♦ The light switch is faulty. 	<ul style="list-style-type: none"> ♦ Check if the power source is enabled. ♦ Replace the light switch. ♦ If all previous attempts failed, contact your local authorized COVANA dealer.
Posts are not equally positioned.	<ul style="list-style-type: none"> ♦ The post screws (attached to the inner sleeve) are missing or have loosened. ♦ A drive shaft has fallen off. ♦ A chain skipped during operation. ♦ A spring pin at the bottom of a jack is broken. 	<ul style="list-style-type: none"> ♦ Lower the COVANA cover completely and screw the self-drilling screws as explained in the installation manual (page 35). ♦ Re-install any fallen drive shaft. ♦ Replace any broken chain. ♦ Replace any missing or broken spring pin. ♦ If all previous attempts failed, contact your local authorized COVANA dealer.
Shades are loose, retract improperly and/or disconnect from the brackets. Shades are wrinkling or bulging at the roller.	<ul style="list-style-type: none"> ♦ The internal spring is not wound enough. ♦ Too much tension in the internal spring ♦ Holding brackets not parallel 	<ul style="list-style-type: none"> ♦ Consult shade installation manual. ♦ Remove the bottom bar and reset the tension back to "4 turns". ♦ Make sure the outer sleeves are sitting on the foot plate, reposition the holding bracket so the roller shade is moving straight.
Middle sleeve has dropped.	<ul style="list-style-type: none"> ♦ The middle sleeve froze on the inner sleeve. ♦ The stopper kit is broken/missing. 	<ul style="list-style-type: none"> ♦ Check the position of the all-weather seals. While cover is closed, it must be sitting on the top of the outer sleeve. ♦ Check if the stopper kit is broken/missing. ♦ If all previous attempts failed, contact your local authorized COVANA dealer.
Cover raises unevenly.	<ul style="list-style-type: none"> ♦ A chain is broken. ♦ A spring pin is broken. ♦ A drive shaft has fallen off. 	<ul style="list-style-type: none"> ♦ Contact your local authorized COVANA dealer for technical support immediately. ♦ Do not operate the Covana cover.

Cover raises but does not lower.	<ul style="list-style-type: none"> ◆ The cam plate is incorrectly positioned or missing. ◆ The key switch is faulty. ◆ Limit switches cannot move properly. 	<ul style="list-style-type: none"> ◆ <i>Certified electrician only.</i> Open the operator and check for faulty up and down limit switches. ◆ Remove power before performing any electrical work. ◆ Check if there is any corrosion on the terminals. If yes, clean the terminals. ◆ Open the key switch terminal and check for faulty switches. ◆ Check if any electrical cables are damaged or pinched.
Cover lowers but does not rise.	<ul style="list-style-type: none"> ◆ The cam plate is missing. ◆ The key switch is faulty. ◆ Limit switches cannot move properly. 	<ul style="list-style-type: none"> ◆ <i>Certified electrician only.</i> Open the operator and check for faulty up and down limit switches. ◆ Remove power before performing any electrical work. ◆ Check if there is any corrosion on the terminals. If yes, clean the terminals. ◆ Open the key switch terminal and check for faulty switches. ◆ Check if any electrical cables are damaged or pinched.
Cover seal turned black.	<ul style="list-style-type: none"> ◆ The seal has accumulated mold. 	<ul style="list-style-type: none"> ◆ Clean the affected areas with bleach and a soft brush. Rinse well with water.
Magnetic plate is not holding in place	<ul style="list-style-type: none"> ◆ Excessive tension in the Constant Tension System (CTS) 70.* ◆ CTS 70 is stuck in place. 	<ul style="list-style-type: none"> ◆ Lift the side of the outer shell where the cable exits from the inner shell; remove the CTS 70 from the steel frame and grease the interior surfaces. ◆ Check that the CTS 70 pulley carrier can travel the length of the CTS 70 without interfering with any object.

* Refer to the Installation Manual for more information

APPENDIX

Wiring & Schematic Diagram - 120VAC, 60Hz Operator (North America)

Operating and circuit logic operation

- 120 VAC, 60Hz control circuit.
- Constant pressure on UP and DOWN.
- Key-switch 3-position.
- Up position - will raise the spa cover to up position.
- Down position - will lower the spa cover to low position.
- OFF position - will disable the controls.

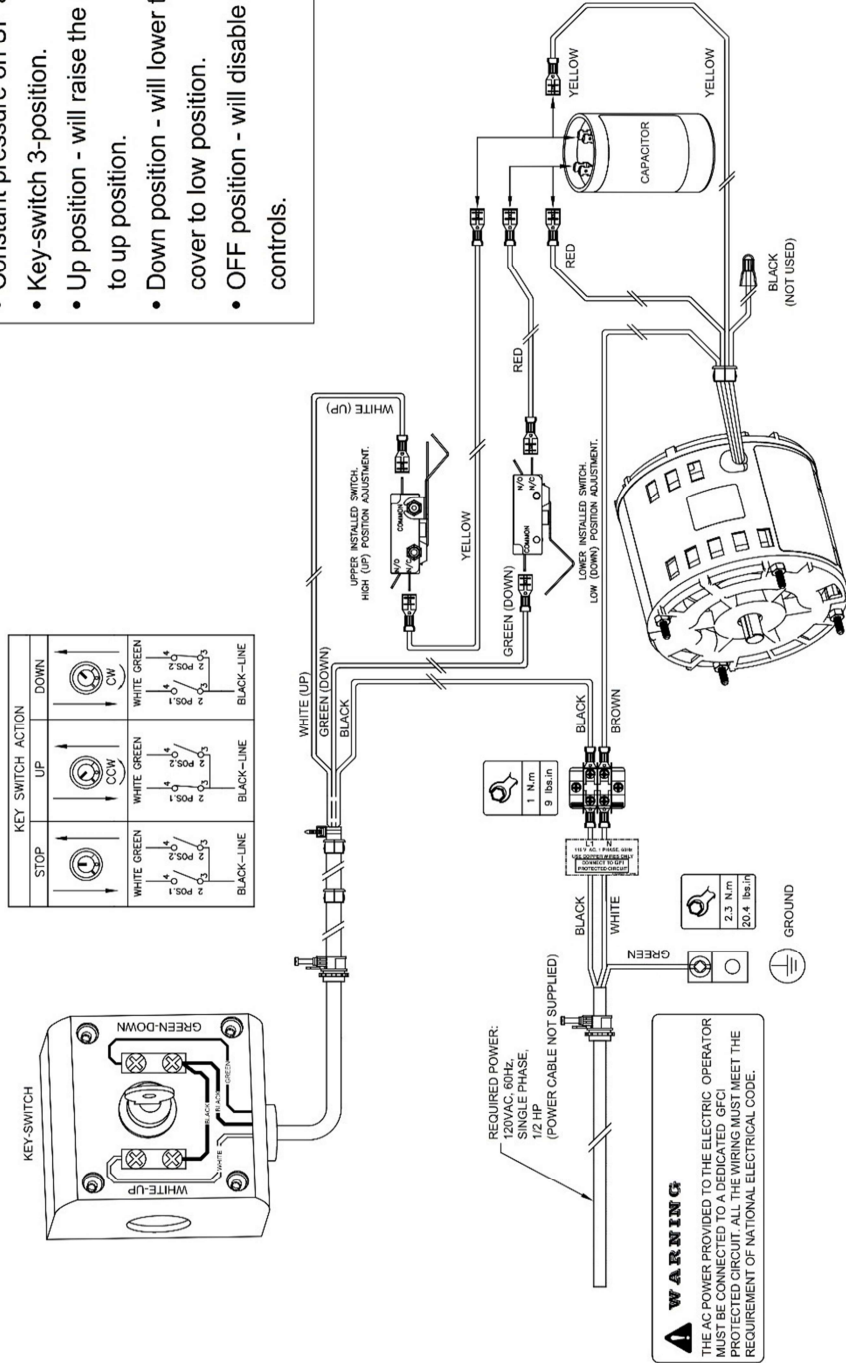

WARNING
THE AC POWER PROVIDED TO THE ELECTRIC OPERATOR MUST BE CONNECTED TO A DEDICATED GFCI PROTECTED CIRCUIT. ALL THE WIRING MUST MEET THE REQUIREMENT OF NATIONAL ELECTRICAL CODE.

WARNING
TWO COPPER GROUND TERMINALS ARE SUPPLIED FOR BONDING.
USE SOLID COPPER CONDUCTOR NOT SMALLER THAN 6 AWG (AS PER UL 2452 ARTICLE #13/ NEC ARTICLE 680)

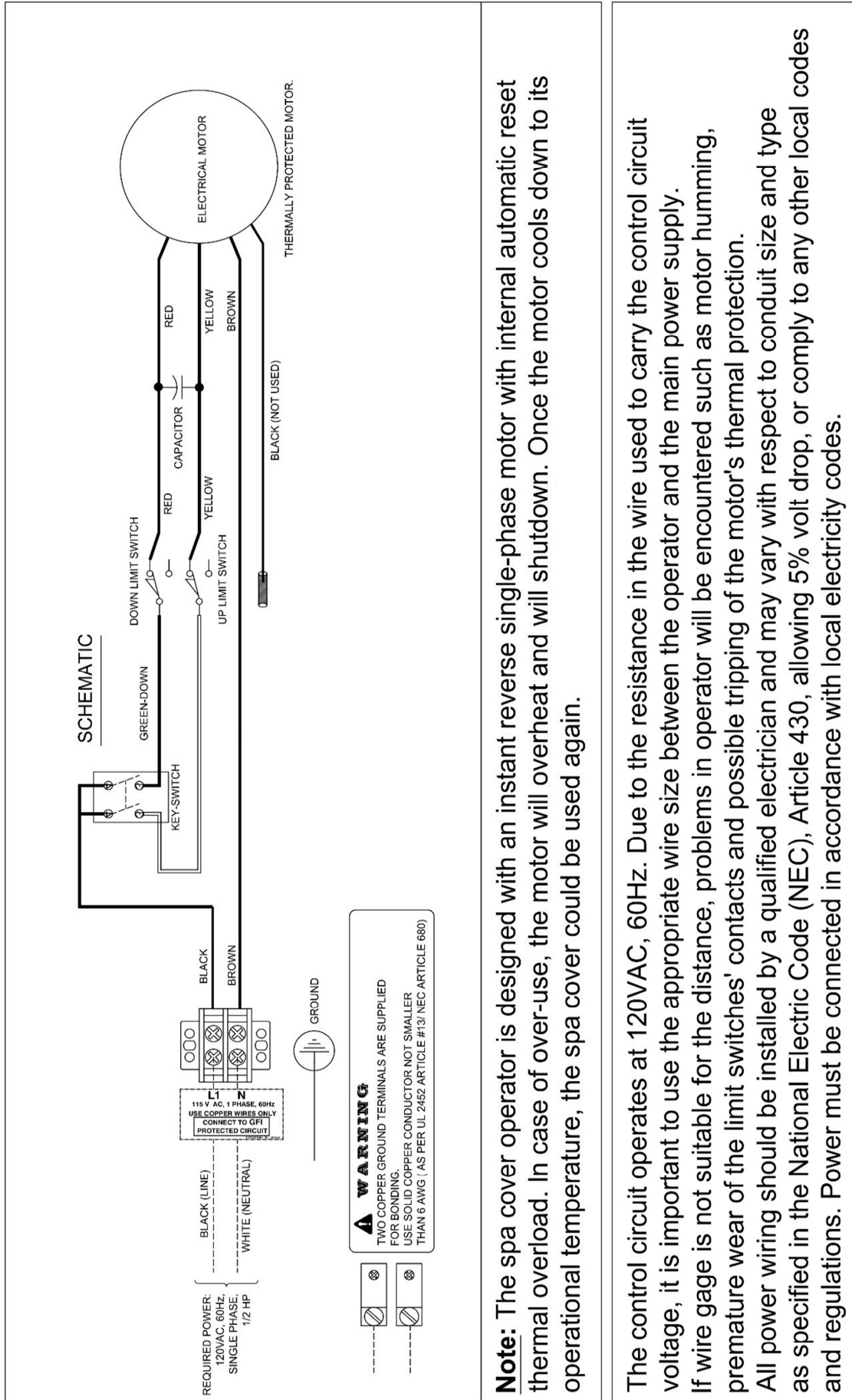

Note: The spa cover operator is designed with an instant reverse single-phase motor with internal automatic reset thermal overload. In case of over-use, the motor will overheat and will shutdown. Once the motor cools down to its operational temperature, the spa cover could be used again.

The control circuit operates at 120VAC, 60Hz. Due to the resistance in the wire used to carry the control circuit voltage, it is important to use the appropriate wire size between the operator and the main power supply. If wire gage is not suitable for the distance, problems in operator will be encountered such as motor humming, premature wear of the limit switches' contacts and possible tripping of the motor's thermal protection. All power wiring should be installed by a qualified electrician and may vary with respect to conduit size and type as specified in the National Electric Code (NEC), Article 430, allowing 5% volt drop, or comply to any other local codes and regulations. Power must be connected in accordance with local electricity codes.

Wiring & Schematic Diagram - 120VAC, 60Hz Operator LIGHT KIT (North America)

Operating and circuit logic operation

- 120 VAC, 60Hz control circuit.
- Constant pressure on UP and DOWN.
- Key-switch 3-position.
- Up position - will raise the spa cover to up position.
- Down position - will lower the spa cover to low position.
- OFF position - will disable the controls.

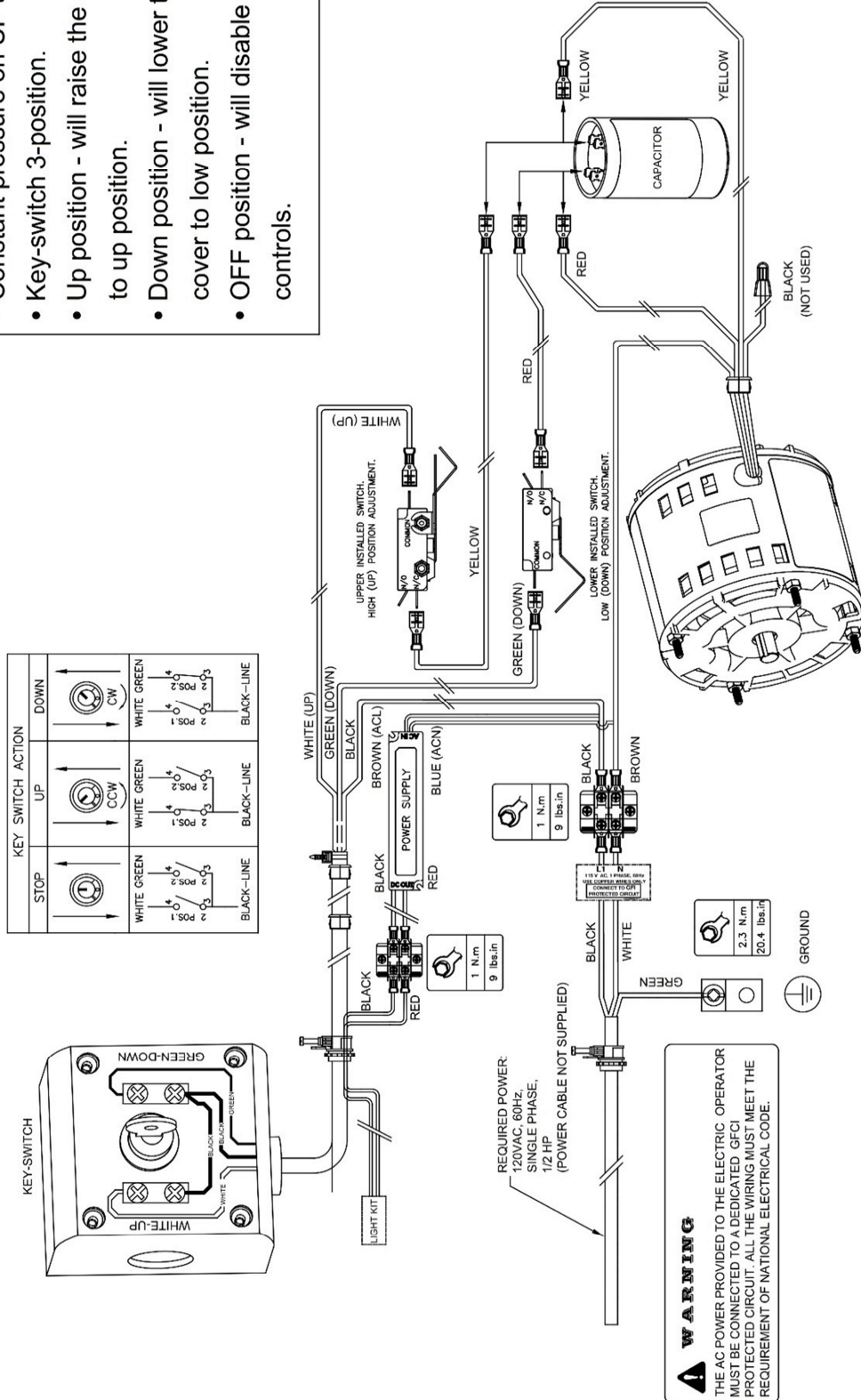

WARNING
THE AC POWER PROVIDED TO THE ELECTRIC OPERATOR MUST BE CONNECTED TO A DEDICATED GFCI PROTECTED CIRCUIT. ALL THE WIRING MUST MEET THE REQUIREMENT OF NATIONAL ELECTRICAL CODE.

WARNING
TWO COPPER GROUND TERMINALS ARE SUPPLIED FOR BONDING. USE SOLID COPPER CONDUCTOR NOT SMALLER THAN 6 AWG (AS PER UL 2452 ARTICLE #13/NEC ARTICLE 680)

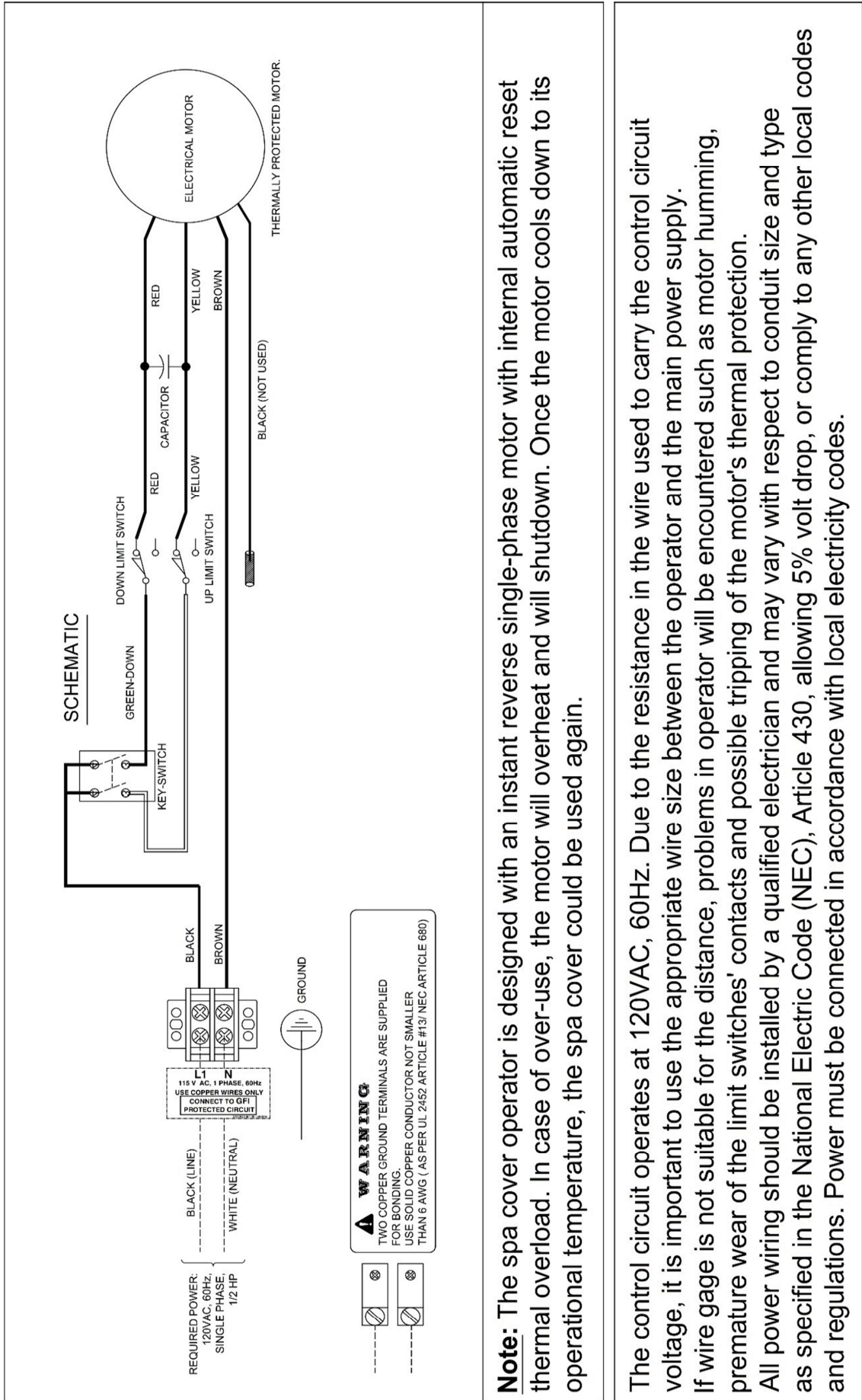

Note: The spa cover operator is designed with an instant reverse single-phase motor with internal automatic reset thermal overload. In case of over-use, the motor will overheat and will shutdown. Once the motor cools down to its operational temperature, the spa cover could be used again.

The control circuit operates at 120VAC, 60Hz. Due to the resistance in the wire used to carry the control circuit voltage, it is important to use the appropriate wire size between the operator and the main power supply. If wire gage is not suitable for the distance, problems in operator will be encountered such as motor humming, premature wear of the limit switches' contacts and possible tripping of the motor's thermal protection. All power wiring should be installed by a qualified electrician and may vary with respect to conduit size and type as specified in the National Electric Code (NEC), Article 430, allowing 5% volt drop, or comply to any other local codes and regulations. Power must be connected in accordance with local electricity codes.

Wiring & Schematic Diagram - 220VAC, 50Hz Operator (Europe only)

Operating and circuit logic operation

- 220 VAC, 50Hz control circuit.
- Constant pressure on UP and DOWN.
- Key-switch 3-position.
- Up position - will raise the spa cover to up position.
- Down position - will lower the spa cover to low position.
- OFF position - will disable the controls.

WIRING

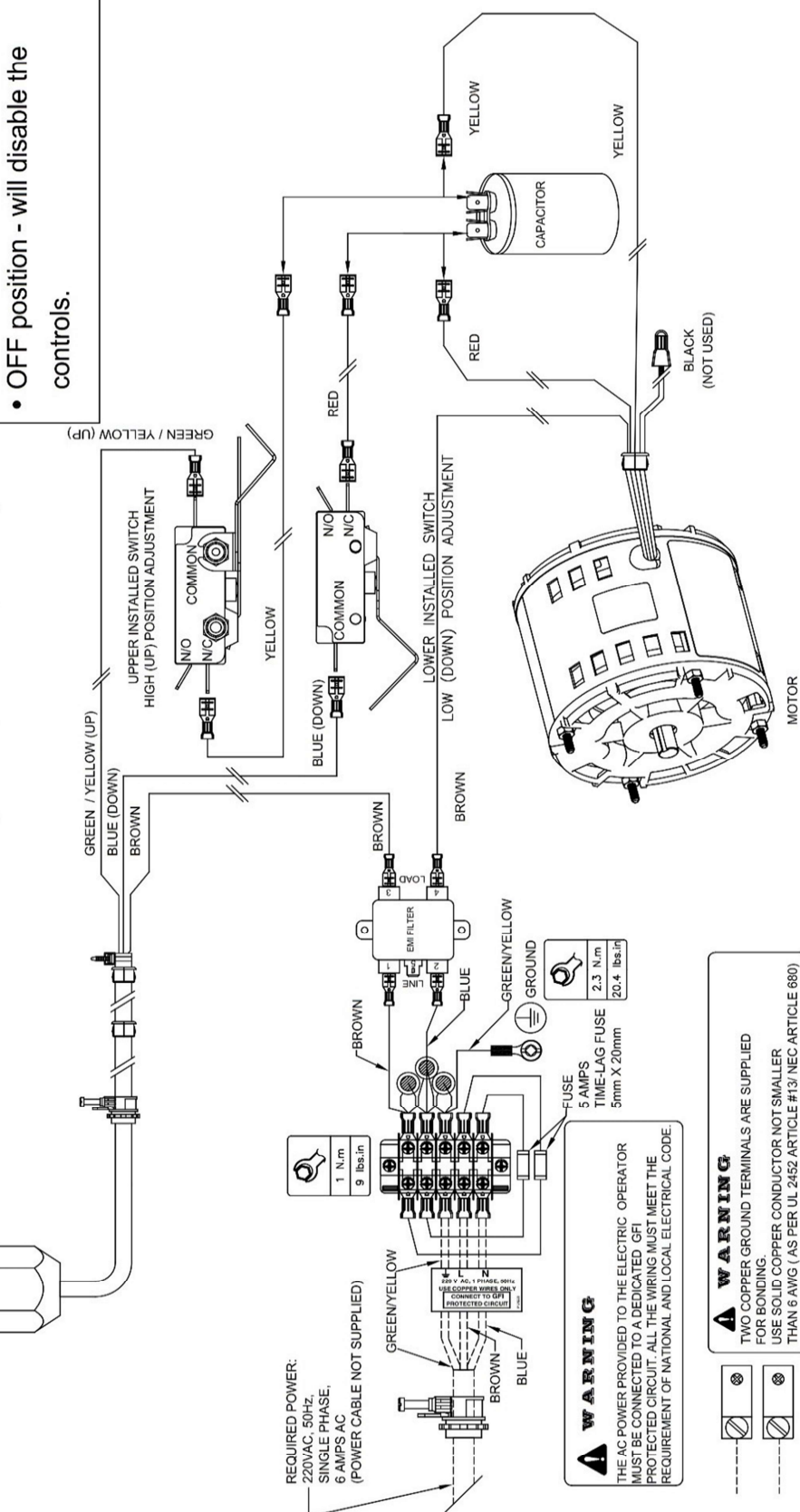
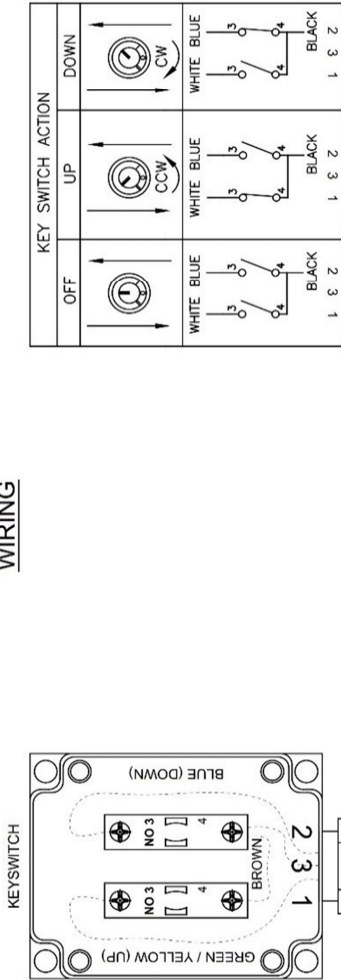

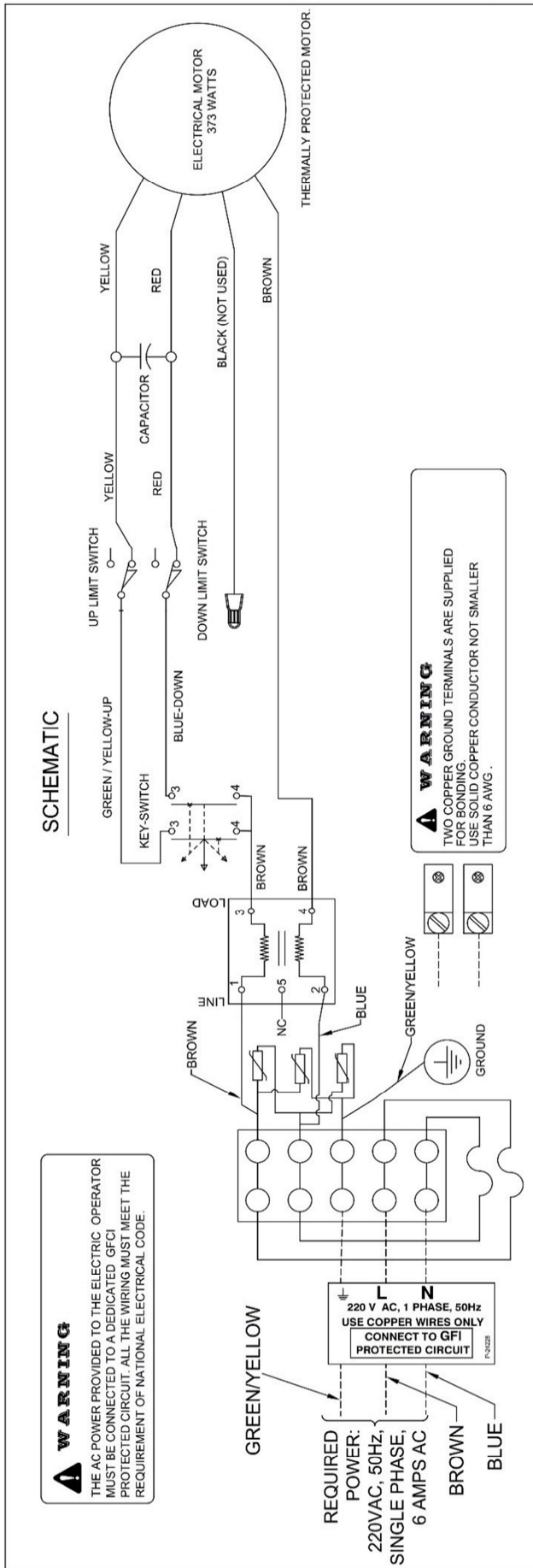

Note: The spa cover operator is designed with an instant reverse single-phase motor with internal automatic reset thermal overload. In case of over-use, the motor will overheat and will shutdown. Once the motor cools down to its operational temperature, the spa cover could be used again.

The control circuit operates at 220 VAC, 50Hz. Due to the resistance in the wire used to carry the control circuit voltage, it is important to use the appropriate wire size between the operator and the main power supply. If wire gage is not suitable for the distance, problems in operator will be encountered such as motor humming, premature wear of the limit switches' contacts and possible tripping of the motor's thermal protection. All power wiring should be installed by a qualified electrician and may vary with respect to conduit size and type as specified in the National Electric Code (NEC), Article 430, allowing 5% volt drop, or comply to any other local codes and regulations. Power must be connected in accordance with local electricity codes.

Wiring & Schematic Diagram-Light kit - 220VAC, 50Hz Operator (Europe only)

WIRING

- ### Operating and circuit logic operation
- 220 VAC, 50Hz control circuit.
 - Constant pressure on UP and DOWN.
 - Key-switch 3-position.
 - Up position - will raise the spa cover to up position.
 - Down position - will lower the spa cover to low position.
 - OFF position - will disable the controls.

KEY SWITCH ACTION	UP	DOWN
	WHITE BLUE CCW	WHITE BLUE CW
	1 3 4	1 3 4
	BLACK	BLACK
	1 1 2	1 1 2

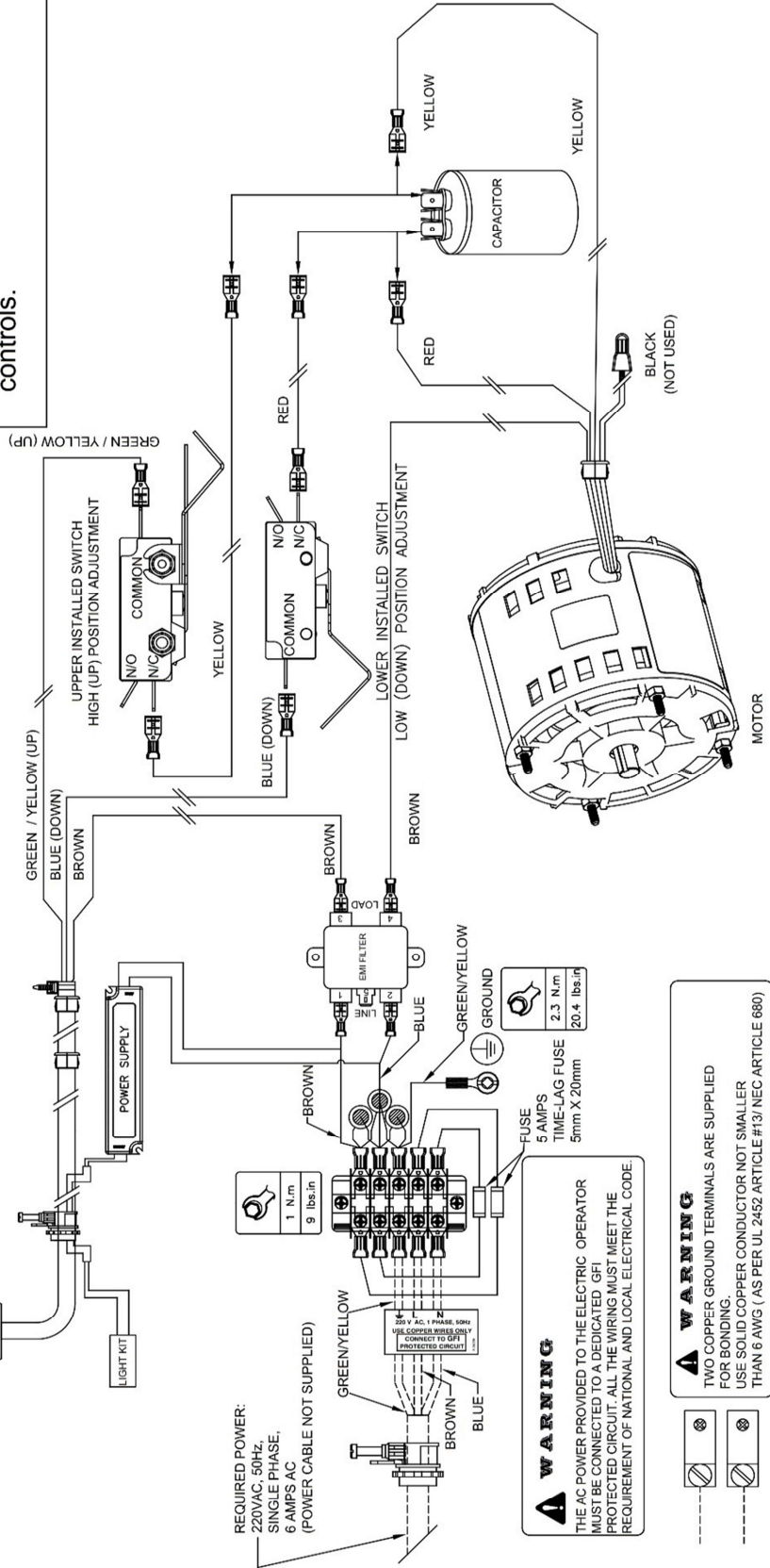
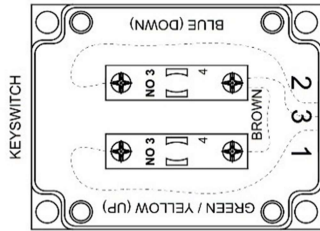

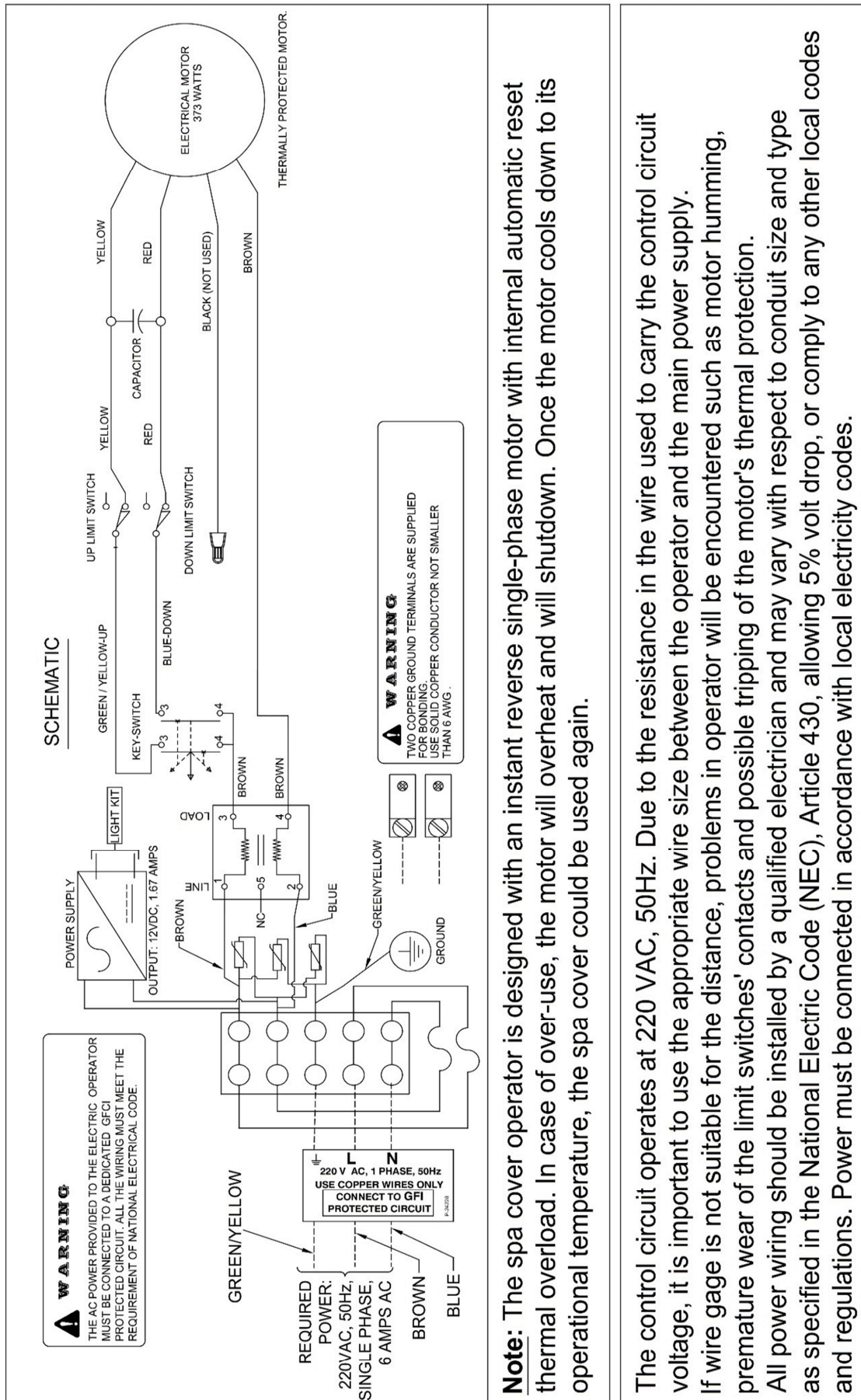

Note: The spa cover operator is designed with an instant reverse single-phase motor with internal automatic reset thermal overload. In case of over-use, the motor will overheat and will shutdown. Once the motor cools down to its operational temperature, the spa cover could be used again.

The control circuit operates at 220 VAC, 50Hz. Due to the resistance in the wire used to carry the control circuit voltage, it is important to use the appropriate wire size between the operator and the main power supply. If wire gage is not suitable for the distance, problems in operator will be encountered such as motor humming, premature wear of the limit switches' contacts and possible tripping of the motor's thermal protection. All power wiring should be installed by a qualified electrician and may vary with respect to conduit size and type as specified in the National Electric Code (NEC), Article 430, allowing 5% volt drop, or comply to any other local codes and regulations. Power must be connected in accordance with local electricity codes.

(This page is intentionally left blank,
see next page)

INSTALLATION CHECKLIST (Customer copy)

To ensure proper installation, you must carefully read this checklist and confirm that you have completed every step of the installation. The customer must receive a completed copy of this checklist.

(Please check each box)

- The base preparation steps are done correctly. **(Location and foundation preparation sections)**
- The installation steps are done correctly. **(Uncrating, cover assembly, lifting mechanism and electrical hook-up sections)**
- The seal is properly installed and there is no steam leaking out around the cover. **(Seal application section)**
- The wiper brackets are properly installed to ensure the cover is watertight. **(Applying the wiper brackets section)**
- The key switch is **permanently installed** 5 ft (1.5 m) away from the swim spa and 5 ft (1.5 m) above the ground.
- The electrical portion of the installation was done by a certified electrician. **(Electrical hook-up, limit switch adjustment sections)**
- All the parts that came with the COVANA cover are installed.
- The start-up procedure is completed. **(The key sequence responds correctly and Testing the COVANA cover section is completed.)**
- The all-weather seal functions properly. **(The cover raises and lowers properly.)**
- The middle sleeves slide freely. **(Manually slide the middle sleeve up and down when the cover is half open.)**

Serial number: _____

Installer's name: _____

Installer's signature: _____

Customer's name: _____

Customer's signature: _____

Customer's address: _____

Date (YYYY/MM/DD): _____

Dealer's name: _____



Contact your dealer for all service-related issues.

Made in Canada by COVANA,
a division of Canimex Group.
www.COVANA.com

PATENTED

CANADA 2,532,429

US 11/162,557

UK 0515168.3

AUSTRALIA 2006200251

The information in this manual was accurate at the time of print. The manufacturer reserves the right to change or improve its product without prior notice.

INSTALLATION CHECKLIST (Installer copy)

To ensure proper installation, you must carefully read this checklist and confirm that you have completed every step of the installation. The customer must receive a completed copy of this checklist.

(Please check each box)

- The base preparation steps are done correctly. **(Location and foundation preparation sections)**
- The installation steps are done correctly. **(Uncrating, cover assembly, lifting mechanism and electrical hook-up sections)**
- The seal is properly installed and there is no steam leaking out around the cover. **(Seal application section)**
- The wiper brackets are properly installed to ensure the cover is watertight. **(Applying the wiper brackets section)**
- The key switch is **permanently installed** 5 ft (1.5 m) away from the swim spa and 5 ft (1.5 m) above the ground.
- The electrical portion of the installation was done by a certified electrician. **(Electrical hook-up, limit switch adjustment sections)**
- All the parts that came with the COVANA cover are installed.
- The start-up procedure is completed. **(The key sequence responds correctly and Testing the COVANA cover section is completed.)**
- The all-weather seal functions properly. **(The cover raises and lowers properly.)**
- The middle sleeves slide freely. **(Manually slide the middle sleeve up and down when the cover is half open.)**

Serial number: _____

Installer's name: _____

Installer's signature: _____

Customer's name: _____

Customer's signature: _____

Customer's address: _____

Date (YYYY/MM/DD): _____

Dealer's name: _____



